

MD 型矿用耐磨多级离心泵

# 安 装 使 用 说 明 书

**An Zhuang Shi Yong Shuo Ming Shu**

通过 ISO9001 · 2008 国际质量管理体系认证



锦 州 大 洋 泵 业 制 造 有 限 公 司

## 使用前请认真阅读使用说明书

### 安全警告：

- 1) 使用本产品之前必须认真阅读本产品使用说明书及相关配套产品的使用说明书。在安装、使用和维修过程中，必须遵循本产品及相关设备的安全操作规程。
- 2) 泵不得长时间在小流量或零流量下运转，否则会引起泵机组振动甚至抽送液体汽化，造成人身伤害和设备的损坏。
- 3) 泵为旋转设备，在安装、维修泵机组前必须切断电源，否则会造成人身伤害。
- 4) 泵在使用前必须检查电缆线有无破损、折断以及接地是否良好。泵机组运行时，严禁手进入或拆下防护罩，否则会造成人身伤害。
- 5) 泵在使用前，请先接通电源，“点启动开关按钮”，确定旋转方向正确无误后，方可使用。
- 6) 对煤矿井下配用电机，YB2 系列电机可用于井下，但不能用于采掘工作面，用于采掘工作面必须配用 YBK 系列电机，Y 系列电机不能用于井下。
- 7) 必须安装联轴器防护罩，以防发生人身伤亡事故。
- 8) 为防止泵运转后，因泵轴与电机轴相抵出现断轴甚至烧电机等事故，因而在调整泵、电机两个联轴器间隙前，必须先将泵轴向泵联轴器方向最大限度的外拉，然后再按说明书要求进行间隙调整。
- 9) 用户与本企业均不得随意变更安标配套件及零（元）部件配置。

## 目 录

1 概述.....	(04)
2 结构说明.....	(05)
3 泵的装配与检测 .....	(05)
4 泵的安装 .....	(05)
5 泵的运转 .....	(07)
6 泵的维修.....	(08)
7 泵运输与贮存 .....	(10)
8 易损件明细表.....	(11)
9 受控主要零（元）部件明细表 .....	(12)
10 MD 型矿用耐磨多级离心泵性能曲线 .....	(13)
11 MD 型矿用耐磨多级离心泵安装图 .....	(48)
12 MD 型矿用耐磨多级离心泵安装尺寸表 .....	(51)

## 1 概述

1.1 MD 系列煤矿用耐磨多级离心泵，是在 D 型单级多吸离心泵的基础上，改造设计的一种耐磨多级离心泵，其主要材料采用耐磨合金铸铁及铬钢，具有高效节能、耐磨、可靠、寿命长，特别适用于煤矿输送清水及固体颗粒含量不大于 1.5%（体积浓度）的中性矿井水（粒度小于 0.5mm）以及类似的其它污水中，被输进介质温度不高于 80℃ 的泵；

### 1.2 水泵运转条件及寿命

1.2.1 在清水条件（固体颗粒含量低于 0.1%）MD 型泵运行 5000 小时无大修；

1.2.2 在固体颗粒含量 1%-5% 污水条件下使用 MD 型泵运行 5000 小时无大修。

### 1.3 本型系列性能范围

性能范围

流量：6~600m<sup>3</sup>/h

扬程：17~1560 m

各种型号的性能参数。详见性能曲线

### 1.4 型号意义说明：

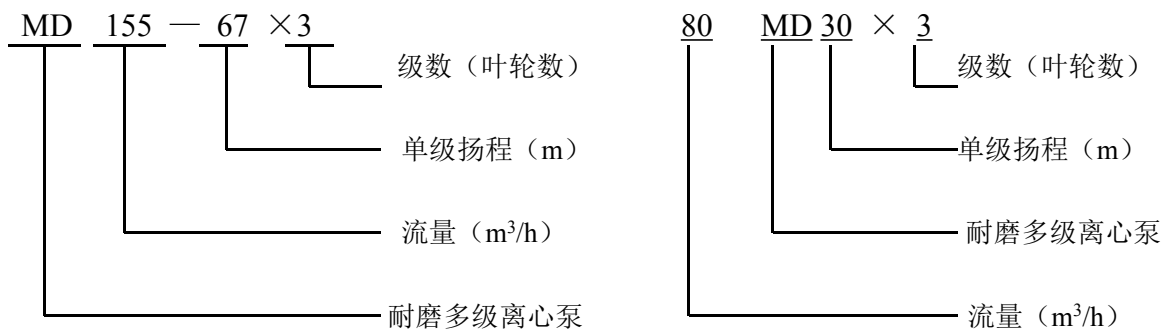

### 1.5 产品执行标准：MT/T114-2005（煤矿用多级离心泵）



图 1

1. 瓜型弹性联轴器 2. 轴 3. 滚动轴承体 4. 填料压盖 5. 吸入段 6. 密封环 7. 中段 8. 叶轮 9. 导叶 10. 导叶套 11. 平衡水管 12. 吐出段 13. 平衡套（环） 14. 平衡盘 15. 填料函体 16. 轴承

MD 型煤矿用耐磨多级离心泵

MD 型煤矿用耐磨多级离心泵

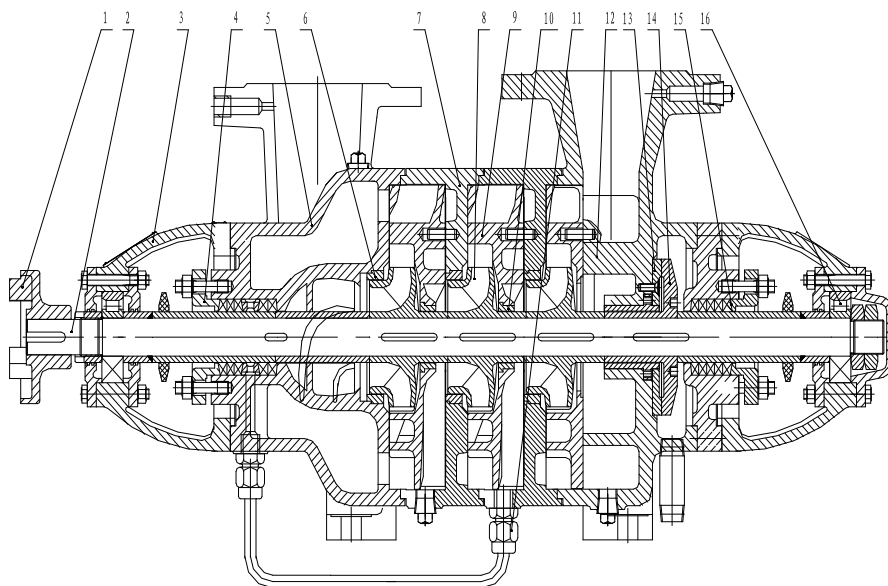
## 2 结构说明

本系列卧式多级离心泵为两端支承。壳体部分是节段式。泵的传动方式是通过弹性联轴器与电动机联结；泵的旋转方向，从驱动端看泵，为顺时针方向旋转。

泵的结构说明参见图 1；

### 2.1 定子部分

主要由吸入段、中段、吐出段、导叶、填料函体等分别用拉紧螺栓和螺母联接成一体。吐出口均垂直向上；吸入口 MD 型泵为水平方向。

### 2.2 转子部分

主要由轴、叶轮、平衡盘及轴套等零件组成。

### 2.3 泵的密封

2.3.1 吸入段、中段、吐出段之间的静止结合面用纸垫来密封。

2.3.2 泵各级间采用节流密封。

2.3.3 泵的两侧轴封采用软填料密封或机械密封。

2.3.4 采用挡水圈挡水，防止水进入轴承。

### 2.4 轴承部分

整个转子由轴两端的滚动轴承来支承。轴承采用油脂润滑。

## 3 泵的装配与检测

本型泵装配质量的好与坏，对泵的性能及运行稳定性影响特别显著。诸如叶轮出口中心与导叶进口中心的对准，泵的转子部分与定子部分的各个密封间隙大小及均匀等。装配时应按图纸的技术要求执行，方能保证装配质量。

### 3.1 转子部件



图 2

以两轴承为支承分别测量叶轮口环、叶轮挡套（或叶轮后脐子）、平衡挡套和轴套的圆跳动值  $a$  及平衡盘端面的跳动值  $b$  应符合转子结合部图纸（随机图纸）的要求。

### 3.2 定子部件

测量转子轴向窜动量、平衡环（套）的端面跳动值，应符合总装图的要求。

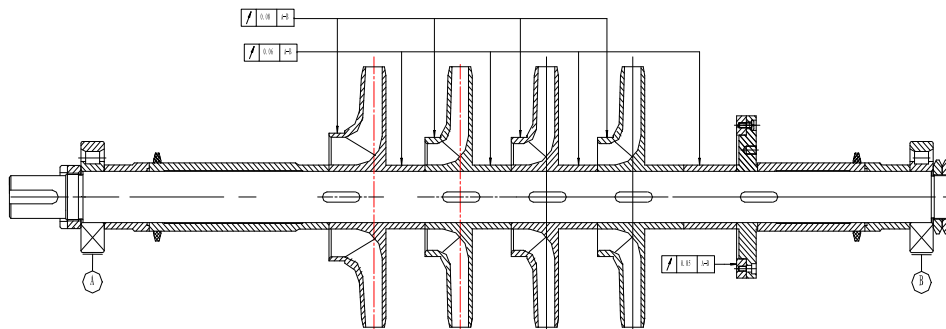
3.3 装配完毕后，用手盘动转子，检查泵内是否有摩擦声或转动不灵活等不正常现象。

## 4 泵的安装

### 4.1 泵的安装步骤

泵的安装步骤一般包括把泵放到地基上,找水平、调正和联接泵的管路等。

### 4.2 泵安装时需要的设备

泵安装时需要下列常规的和专用的设备和工具;

- a.有负载能力合适而安全的起重设备;
- b.每个地脚螺栓处都必须备有一块钢的垫铁或楔铁, 作找平底座用;
- c.灌浆的材料必须是不收缩的灌浆料, 为了灌浆需准备一个木盒, 而且需配有漏斗;
- d.为了安装和拆卸填料, 需要一套专用的工具, 如带钩的夹具等。

### 4.3 泵的开箱检查

泵运到使用单位应开箱检查泵的零件是否丢失。是否在运输过程中有损坏。如果出现有丢失或损坏时, 应立即向运输部门和泵制造厂声明。

### 4.4 泵的基础

4.4.1 泵的基础必须具有足够强度和尺寸的混凝土地基。基础的质量约等于机组质量的 3-5 倍。泵的地基应比泵的底座长出 50-70, 且要留出地脚孔(为地脚螺栓底部宽度 3-4 倍的钢管直径)。

4.4.2 打地基包括如下内容: 地基的地脚螺栓孔的定位, 灌浆和留在外联接管路位置, 然后在其余空间灌浆;

4.4.3 地基的表面可以是粗糙的, 以使灌浆效果的好。

4.4.4 地基完全固化后再安置设备。

### 4.5 搬放和找水平

4.5.1 在底座下面放置钢的垫铁和楔铁或调整垫。一般都放置在地脚螺栓处。如果底座较长, 在两地脚螺栓的中间可放置一块垫铁。

4.5.2 检查底座下面的地基, 清洗灰尘、油和其它杂物。

4.5.3 起重吊钩吊在底座的四个角上, 把底座吊在地基上方, 慢慢地把底座放在每个螺栓孔的位置上(对准地脚螺栓孔的位置);

4.5.4 用一个刀口平尺和机械水平仪放到安放泵和电机底脚加工平面上, 用调整楔铁或调整垫的厚度来确定底座在各个方位上的水平, 推荐每 100 毫米长度不平度小于 0.25 毫米, 这时地脚螺栓的螺母拧到适当的程度 (不能过紧), 楔钢或调整垫片应紧固;

4.5.5 底座找平, 而且和地基配合较紧后再灌浆;

### 4.6 底座的灌浆

4.6.1 灌浆时, 确保做到每个空间的空气必须全部排出。

4.6.2 当灌浆材料固化后, 拧紧地脚螺栓的螺母。然后再对灌浆材料涂油漆防潮。

4.6.3 灌浆后, 进行泵和电动机的调整工作。

### 4.7 设备的调整

设备调正包括角度调正和中心线位置的调正, 至少应在下面三个时期检查设备, 进行调正:

第一次、泵和底座已经把紧，但电动机没把紧；

第二次、泵和电动机已经紧固，但吸入和吐出管路法兰的螺栓没紧固；

第三次、在泵运转 24 小时后，再检查一次，检查后把泵和电动机最后坚固。

在调正工作中应注意以下事宜：

- a) 在调正以前，检查全部管线，保证它们不对泵座产生作用力或力矩；
- b) 在调正泵和电动机时，垫片应垫在电动机的下面；

角度调正是保证联轴器的两个平面的平行度。用一块千分表去检查联轴器法兰端面上四个点，千分表读数为 0.02-0.03；检查其平行度也可用塞尺；两联轴器平面间的差值(a-b)≤0.06，用塞尺测量；

中心线对中是指泵和电动机轴中心线的对正程度。用直尺在两联轴器圆周各个方向测量，两联轴器外圆表面直尺间隙允差应使 c≤0.08(见下图)，不符合时可用调整垫进行调整。

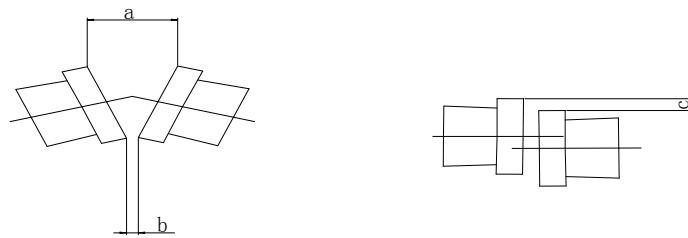

#### 4.8 主要管路的联接

泵灌浆后且紧固在地基上以后，在不受外力条件下对正且联接泵法兰和管路的法兰。这个对正联接不能依靠法兰螺栓的力。

对管路支撑(附加)应避免管路系统的振动，应减少管路对泵的外加力；

为了防止泵的损坏，在泵管路联接以前要对管路系统进行清洗。

安装管路，应注意事项：

- a)使用管路的规格和长度应合适，且有足够的承压能力，尽量减少管路的转弯和附件；
- b)泵的吸入管路应是短而直、管路直径应大于或等于泵的吸入口的直径，泵的吸水管路的弯曲半径应做成尽量大；

#### 4.9 辅助设备的联接

##### 4.9.1 压力表

在吸入管路和吐出管路上用的压力表必须是质量好、性能合格的仪表：

吐出压力表最好装配在泵吐出法兰的 2 倍直径长的距离上，不能装在弯管和阀的旁边，以防受不稳定流动的干扰；

##### 4.9.2 联轴器

泵和电机联轴器联接以前重新检查其对中心；检查电动机的转向是否符合要求，泵轴的转向；从联轴器方向看泵为顺时针方向旋转，如果电动机转向不符泵的转向，必须把电动机转向调正过来。

##### 4.9.3 轴封

如果需要，在泵运转以前，重新调整轴封或重新装配。



## 5 泵的运转

### 5.1 操作注意事项

5.1.1 泵只允许在规定的参数范围内运转；

5.1.2 泵不允许在吐出阀门关闭或关到很小开度下运转，否则导致泵发热、降低寿命，如果泵是安装在一个并联系统中，每台泵都要在特定的参数下运行以保证泵的流量；

5.1.3 泵不能关吸入口阀运行，否则使泵发生干转，导致泵零件损坏。

5.1.4 泵输送介质不能含有空气或气体，否则会使泵的流量和扬程不可能准确地测出，同时会产生研磨损坏零件。

5.1.5 该型泵不能输送带颗粒的材料，否则会降低泵的效率 and 零件的寿命；

5.1.6 开泵以前按 5.2 条对泵进行开车前检查；

### 5.2 启泵前检查

5.2.1 启泵前、检查全部螺栓、管路及引线的联接是否紧固；

5.2.2 检查全部仪表、阀门及仪器是否正常

5.2.3 检查油环位置、油位计的油位是否正常。

5.2.4 检查电动机的转向是否正确；

### 5.3 泵的启动

#### 5.3.1 泵启动时注意事项

a、启动时观察压力表和开关的指示，以便调整。

b、在泵吸入阀没有安全打开以前不能开泵。

c、泵启动后，不能使吐出阀关闭或接近关闭或接近关闭较长时间，否则会使泵内液体过热。

#### 5.3.2 启泵步骤

a、按 5.2 条内容进行开车前检查。

b、打开泵的吸入阀和水封水管路和阀。

c、关闭吐出管路的阀，使泵内充满液体。

d、起动电机，接着打开吐出管路的阀。

### 5.4 泵运转检查

泵动转后，应立即按 5.2 条的程序每隔一定的时间检查仪表，以此确定泵的工作是否正常，而且要检查泵的转速，此外，监测泵的压力、扬程、温度及润滑状况。

泵在发生故障时，应停泵、且参考故障排除表进行维修。

### 5.5 停泵

a、将泵的吐出阀关到最小流量，但决不允许关闭泵的吸入阀。

b、关闭电动机。

c、关闭泵的吐出阀。

d、泵停稳后再关闭泵的吸入阀。



## 6 泵的维修

### 6.1 概述

为了保持泵高效稳定的工作状况，泵必须经常维修，维修的项目和每次维修间隔时间取决泵的工作条件和泵的运行状况：

### 6.2 泵的维修

定期检查泵的性能(如流量、扬程、振动等)而且要做记录，按这些记录数据分析泵是否工作正常，是否需要维修，或确定要修的哪一个部位：

故障	原因	解决方法
1、水泵不吸水、压力表及其真空表的指针剧烈跳动。	注入水泵的水不够，吸入管与仪表等处漏气。	再往水泵内注水、拧紧堵塞漏气处。
2、水泵不吸水，真空表表示高度真空。	底阀没有打开或已淤塞、吸水管阻力太大、吸水高度太大。	校正或更换底阀、清洗或更换吸水管、减低吸水高度。
3、看压力表水泵出口处是有压力而水泵不出水。	出水管阻力太大、旋转方向不对，叶轮淤塞、或损坏，水泵转数不够。	检查或缩短水管及检查电机取下水管接头、清洗或更换叶轮提高转数。
4、流量不足。	水泵淤塞、密封环磨损过多，转数不足。	清洗水泵及管子更换密封环提高转数。
5、水泵消耗的功率过大。	填料压盖太紧、填料室发热、叶轮磨损、水泵供水量增加。	拧松填料压盖或更换填料，更换叶轮。增加出水管阻力来减少流量。
6、水泵内部声音反常，水泵不上水。	流量太大、吸水着内阻力过大、吸水高度过大、在吸水处有空气渗入、所吸送液体温度过高。	增加出水管内的阻力以减低流量、检查吸水管和底阀、减小吸水高度、拧紧堵塞漏气处。
7、水泵振动。	泵轴与电机轴线不在同一条中心线上，脏物或水浸入轴承。	把水泵和电机的轴中心线对准，清洗轴承更换润滑油。

在一般条件下，如果坚持精确地测试、记录、定期的总结记录，那么每隔几个月就可以得到泵是否需要维修的可靠资料；

除在规定的对泵监测之外，下面的维护是经常的：

- a.检查泵底座、泵、电动机是否紧固，如果松动会引起泵的振动。
- b.检查仪表、引线的状况，检查管路是否泄漏或松动，或其它形式的损坏、如果需要维修应立即检修。
- c.填料压盖不能压得过紧，否则会影响填料的寿命。
- d.轴承润滑油每工作 1000 小时更换一次。

### 6.3 泵的故障及解决方法：

8、轴承过热。	润滑脂干固或脏了，水泵轴与电机轴不在同一条中心线上。	检查或清洗轴承体更换润滑脂把轴中心对准。
9、平衡水中断，平衡室发热，电机功率增加。	水泵在大流量低扬程运转，平衡盘与平衡板产生研磨。	关小出口闸阀至设计工况运转、拆卸平衡盘进行检修。

## 6.4 泵的拆卸

### 6.4.1 当拆卸泵时应注意下列事项：

- a、按 5.5 条停泵程序停泵；
- b、将泵壳内的液体放掉（如有冷却水套时也应放掉水）；
- c、如果轴承部件是稀油润滑时应将润滑油放掉；
- d、拆去妨碍拆卸的附属管路，如平衡管、水封水管等管路和引线；
- e、应用加热方法拆卸泵联轴器（当需要拆卸电机联轴器时亦应如此）；

### 6.4.2 拆卸顺序

泵的拆卸步骤应从拆下吐出侧的轴承部件开始，其顺序大体如下：

- a. 拧下吐出侧轴承压盖上的螺栓和吐出段，填料函体、轴承体三个件之间的联接螺母卸下轴承部件；
- b. 拧下轴上的圆螺母。依次卸下轴承内圈、轴承压盖和挡套后，卸下填料体（包括填料压盖、填料环、填料等在内）；
- c. 依次卸下轴上的 O 型密封圈、轴套、平衡盘和键后，卸下吐出段（包括末级导叶、平衡套等在内）；
- d. 卸下末级叶轮和键后，卸下中段（包括导叶在内）；按同样方法继续卸下其余各级的叶轮，中段和导叶，直至卸下首级叶轮为止；
- e. 拧下吸入段和轴承体的联接螺母和拧下轴承压盖上的螺栓后，卸下轴承部件（在这之前应先将泵联轴器卸下）；
- f. 将轴从吸入段中抽出，拧下轴上的固定螺母、依次将轴承内圈、O 型密封圈、轴套、挡套等卸下；至此拆卸工作基本完成，但在上述拆卸过程中，还有部分零件互相是联接在一起的，一般情况下拧下联接螺栓或螺母后即可卸下。

MD85-67 和 MD155-67 是采用滑动轴承，其拆卸顺序基本相同，谨在拆卸轴承部件时稍有不同：泵的装配顺序，一般是按拆卸顺序反向进行。

## 6.5 清洗和检查

6.5.1 用煤油清洗全部的零件，在空气中干燥或用布擦干。

6.5.2 检查全部零件的磨损情况，对不能确保正常运转的零件应更换新的。

6.5.3 检查泵轴是否有灰尘或生锈，用千分表检查轴的不直度（轴的径向跳动值不大于 8 级精度）。

6.5.4 当密封间隙超过推荐值的最大值 50%时，应更换密封元件。

### 6.5.5 注意事项

- a、泵与电机安装，调整维修时决不允许带电操作。
- b、起动前必须检查泵和轴承箱内油位是否正确，以及电机旋转方向与泵箭头所指的方向是否相符。

- c、电机与泵轴线必须同心，连接处需安装防护罩。
- d、露天工作时，电机应安装防护罩，以防雨水等浸入电机。

## 7 泵运输与贮存

7.1 水泵经出厂试验后，应除净水泵内积水（以防冻坏泵体）包装后放入货场，而且应放在干燥、防雨、

序号	名称	材料	数量	备注
1	平衡盘	QT600-3	1	
2	平衡环	ZQAl <sub>9-4</sub>	1	
3	平衡套	HT250	1	
4	叶轮	HT200	N	
5	密封环	HT250	N	N 为级数
6	导叶套	HT250	1	
7	各种轴套	45	3-5	根据型号

防灰尘合适场地，泵的吐出口和吸入口应盖住，以防异物进入。

7.2 储存期超过 6 个月以上应检查填料是否锈蚀，有锈蚀现象必须更换。

7.3 在泵搬运时，起重机的吊钩应挂在底座下面，也可以用叉式起重机搬运，不允许吊在泵和电机机的螺栓孔或吊泵的轴承体，更不能在泵轴处起吊；

7.4 起重负载应均匀平衡，且应注意起重设备的承载能力，起吊时应小心谨慎，防止泵体碰撞，特别应避免泵联轴器处轴加工配合面损坏；

7.5 严禁异物或灰尘在搬运过程中进入泵和电机内。

## 8 易损件明细表

8.1 铸件

8.2 轴承（GB/T283-94）

### 9 受控主要零（元）部件明细表

序号	名称	材料	数量	备注
1	电机		1 台	型号见泵安装尺寸表
2	吸入段	HT250	1 个	
3	中段	HT250	N-1	N 代表级数
4	叶轮	HT250	N	N 代表级数
5	吐出段	HT250	1 个	

泵型号	轴承型号	泵型号	轴承型号
MD6-25	2306	MD80-120	轴瓦 70
MD12-25	2306	MD85-45	2309
MD12-50	2308	MD160-120	轴瓦 80
MD25-30	2307	MD220-40	315E
MD25-50	2309	MD250-85	N321
MD46-30	2307	MD360-40	315E
MD46-50	2309	MD500-57	N320E
MD85-67	2313	50MD8	32306
MD85-80	2313	80MD12	306E
MD155-30	2312	80MD30	2307
MD155-67	2313	100MD16	2307
MD280-43	315E	100MD24	32308E
MD280-65	2320	100MD45	2309
MD280-80	N321	125MD25	2308
MD450-60	N320E	150MD30	2312
MD600-65	2320	200MD43	315E
MD25-80	轴瓦 55	250MD60	N320E
MD45-80	轴瓦 55		

10 MD 型矿用耐磨多级离心泵性能曲线

MD6-25 型矿用耐磨多级离心泵性能曲线表 (n=2950r/min)

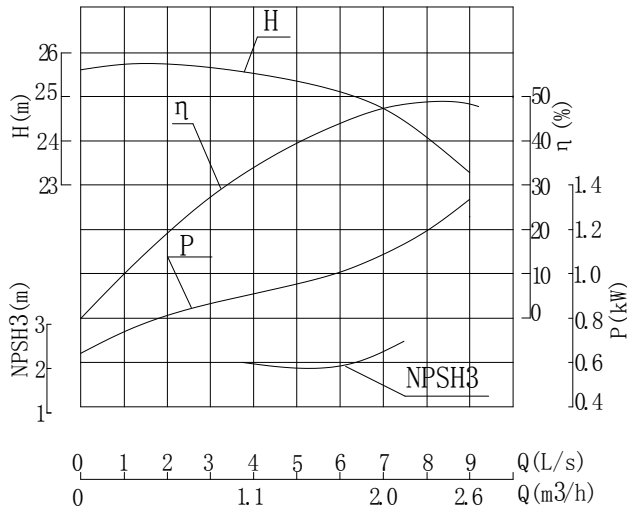

泵的型号	级数	流量 Q		扬程 H (m)	转速 n (r/min)	功率 P (kW)		效率 η (%)	必需汽蚀余量 NPSHR (m)
		(m³/h)	(L/s)			轴功率	电机功率		
MD6-25	2	3.75	1.04	51	2950	1.58	4	33	2
		6.30	1.75	50		1.9		45	2
		7.50	2.08	49		2.13		47	2.5
	3	3.75	1.04	76.5		2.37	5.5	33	2
		6.30	1.75	75		2.86		45	2
		7.50	2.08	73.5		3.19		47	2.5
	4	3.75	1.04	102		3.16	7.5	33	2
		6.30	1.75	100		3.81		45	2
		7.50	2.08	98		4.26		47	2.5
	5	3.75	1.04	127.5		3.95	7.5	33	2
		6.30	1.75	125		4.77		45	2
		7.50	2.08	122.5		5.32		47	2.5
	6	3.75	1.04	153		4.73	11	33	2
		6.30	1.75	150		5.72		45	2
		7.50	2.08	147		6.39		47	2.5
	7	3.75	1.04	178.5		5.52	11	33	2
		6.30	1.75	175		6.67		45	2
		7.50	2.08	171.5		7.45		47	2.5
	8	3.75	1.04	204		6.31	15	33	2
		6.30	1.75	200		7.63		45	2
		7.50	2.08	196		8.52		47	2.5
	9	3.75	1.04	229.5		7.10	15	33	2
		6.30	1.75	225		8.58		45	2
		7.50	2.08	220.5		9.58		47	2.5
	10	3.75	1.04	255		7.89	18.5	33	2
		6.30	1.75	250		9.53		45	2
		7.50	2.08	245		10.65		47	2.5
	11	3.75	1.04	280.5		8.68	18.5	33	2
		6.30	1.75	275		10.50		45	2
		7.50	2.08	269.5		11.71		47	2.5
	12	3.75	1.04	306		9.47	18.5	33	2
		6.30	1.75	300		11.44		45	2
		7.50	2.08	294		12.78		47	2.5

MD12-25 型煤矿用耐磨多级离心泵性能曲线表 (n=2950r/min)

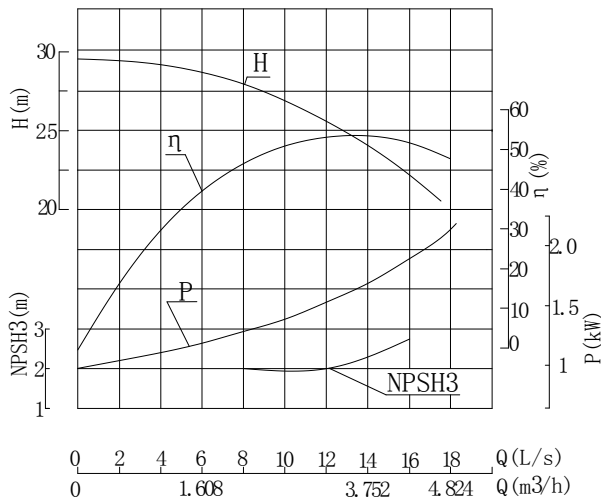

泵的类型	级数	流量 Q		扬程 H (m)	转速 n (r/min)	功率 P (kW)		效率 η (%)	必需汽蚀余量 NPSHR (m)
		(m³/h)	(L/s)			轴功率	电机功率		
MD12-25	2	7.50	2.08	56.4	2950	2.62	5.5	44	2
		12.50	3.47	50		3.15		54	2
		15.00	4.17	46		3.55		53	2.5
	3	7.50	2.08	84.6		3.93	7.5	44	2
		12.50	3.47	75		4.73		54	2
		15.00	4.17	69		5.23		53	2.5
	4	7.50	2.08	112.8		5.24	11	44	2
		12.50	3.47	100		6.30		54	2
		15.00	4.17	92		7.09		53	2.5
	5	7.50	2.08	141		6.55	11	44	2
		12.50	3.47	125		7.88		54	2
		15.00	4.17	115		8.86		53	2.5
	6	7.50	2.08	169.5		7.85	15	44	2
		12.50	3.47	150		9.46		54	2
		15.00	4.17	138		10.64		53	2.5
	7	7.50	2.08	197.4		9.16	15	44	2
		12.50	3.47	175		11.00		54	2
		15.00	4.17	161		12.41		53	2.5
	8	7.50	2.08	225.6		10.47	18.5	44	2
		12.50	3.47	200		12.61		54	2
		15.00	4.17	184		12.18		53	2.5
	9	7.50	2.08	253.8		11.78	18.5	44	2
		12.50	3.47	225		14.18		54	2
		15.00	4.17	207		15.95		53	2.5
	10	7.50	2.08	282		13.09	22	44	2
		12.50	3.47	250		15.76		54	2
		15.00	4.17	230		17.73		53	2.5
	11	7.50	2.08	310.2		14.40	22	44	2
		12.50	3.47	275		17.34		54	2
		15.00	4.17	253		19.50		53	2.5
	12	7.50	2.08	338.4		15.70	30	44	2
		12.50	3.47	300		18.90		54	2
		15.00	4.17	276		21.30		53	2.5

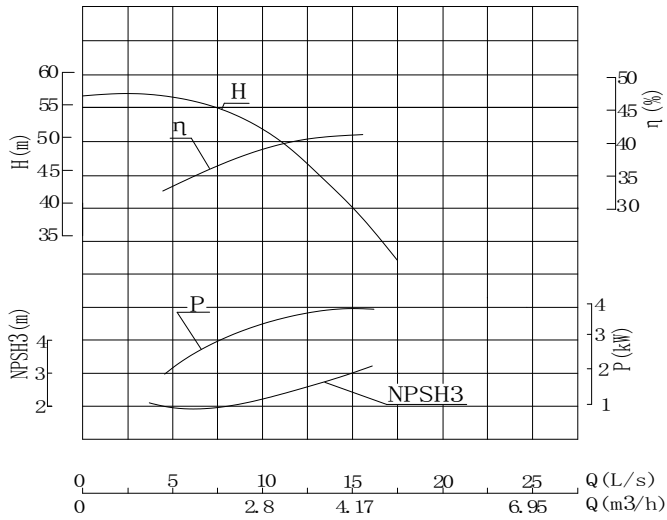

泵的型号	级数	流量 Q		扬程 H (m)	转速 n (r/min)	功率 P (kW)		效率 η (%)	必需汽蚀余量 NPSHR (m)
		(m³/h)	(L/s)			轴功率	电机功率		
MD12-50	2	9.00	2.5	110	2950	6.74	11	34.5	2
		12.54	3.47	100		8.5		40	2.5
		15.00	4.17	90		9.19		41	3
	3	9.00	2.5	165		11.72	15	34.5	2
		12.54	3.47	150		12.76		40	2.5
		15.00	4.17	135		13.46		41	3
	4	9.00	2.5	220		15.62	22	34.5	2
		12.54	3.47	200		17.02		40	2.5
		15.00	4.17	180		17.95		41	3
	5	9.00	2.5	275		19.53	30	34.5	2
		12.54	3.47	250		21.30		40	2.5
		15.00	4.17	225		22.40		41	3
	6	9.00	2.5	330		23.43	30	34.5	2
		12.54	3.47	300		25.50		40	2.5
		15.00	4.17	270		26.90		41	3
	7	9.00	2.5	385		27.34	37	34.5	2
		12.54	3.47	350		29.80		40	2.5
		15.00	4.17	315		31.40		41	3
	8	9.00	2.5	440		31.24	45	34.5	2
		12.54	3.47	400		34.04		40	2.5
		15.00	4.17	360		35.89		41	3
	9	9.00	2.5	495		35.16	45	34.5	2
		12.54	3.47	450		38.30		40	2.5
		15.00	4.17	405		40.38		41	3
	10	9.00	2.5	550		39.05	55	34.5	2
		12.54	3.47	500		42.60		40	2.5
		15.00	4.17	450		44.87		41	3
	11	9.00	2.5	605		42.96	55	34.5	2
		12.54	3.47	550		46.80		40	2.5
		15.00	4.17	495		49.35		41	3
	12	9.00	2.5	660		46.86	75	34.5	2
		12.54	3.47	600		51.00		40	2.5
		15.00	4.17	540		53.84		41	3



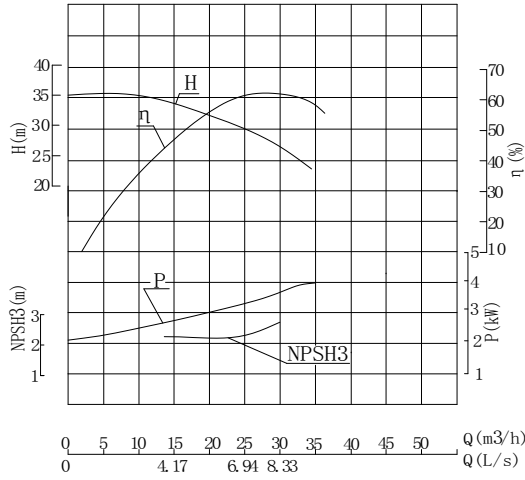

泵的型号	级数	流量 Q		扬程 H (m)	转速 n (r/min)	功率 P (kW)		效率 η (%)	必需汽蚀余量 NPSHR (m)
		(m³/h)	(L/s)			轴功率	电机功率		
MD25-30	2	15	4.17	68	2950	5.56	11	50	2.2
		25	6.94	60		6.59		62	2.2
		30	8.33	55		7.14		63	2.6
	3	15	4.17	102		8.34	15	50	2.2
		25	6.94	90		9.89		62	2.2
		30	8.33	82.5		10.70		63	2.6
	4	15	4.17	136		11.12	18.5	50	2.2
		25	6.94	120		13.18		62	2.2
		30	8.33	110		14.27		63	2.6
	5	15	4.17	170		13.90	22	50	2.2
		25	6.94	150		16.48		62	2.2
		30	8.33	137.5		17.84		63	2.6
	6	15	4.17	204		16.68	30	50	2.2
		25	6.94	180		19.78		62	2.2
		30	8.33	165		21.41		63	2.6
	7	15	4.17	238		19.46	30	50	2.2
		25	6.94	210		23.07		62	2.2
		30	8.33	192.5		24.98		63	2.6
	8	15	4.17	272		22.23	37	50	2.2
		25	6.94	240		26.37		62	2.2
		30	8.33	220		28.55		63	2.6
	9	15	4.17	306		25.01	37	50	2.2
		25	6.94	270		29.67		62	2.2
		30	8.33	247.5		32.11		63	2.6
	10	15	4.17	340		27.79	45	50	2.2
		25	6.94	300		32.96		62	2.2
		30	8.33	275		35.68		63	2.6
	11	15	4.17	374		30.57	55	50	2.2
		25	6.94	330		36.26		62	2.2
		30	8.33	302.5		39.25		63	2.6
	12	15	4.17	408		33.35	55	50	2.2
		25	6.94	360		39.55		62	2.2
		30	8.33	330		42.82		63	2.6

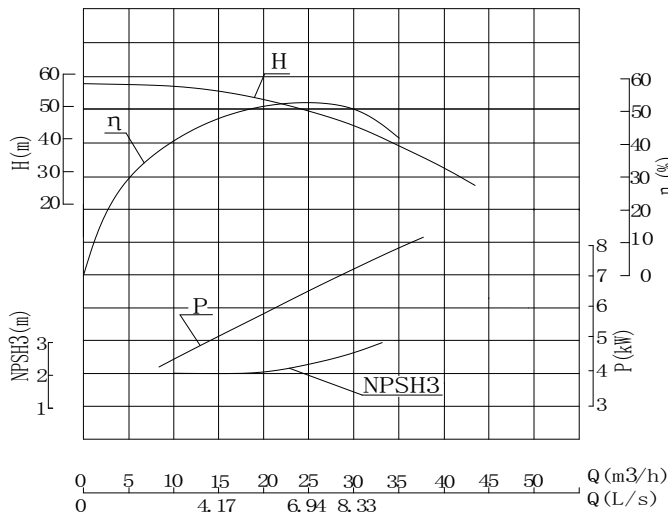

泵的型号	级数	流量 Q		扬程 H (m)	转速 n (r/min)	功率 P (kW)		效率 η (%)	必需汽蚀余量 NPSHR (m)
		(m³/h)	(L/s)			轴功率	电机功率		
MD25-50	2	15	4.17	112.7	2950	9.60	18.5	48	2.0
		25	6.94	100		13.10		52	2.3
		30	8.33	90		14.71		50	2.6
	3	15	4.17	169		14.4	30	48	2.0
		25	6.94	150		19.6		52	2.3
		30	8.33	135		22.1		50	2.6
	4	15	4.17	224		19.1	37	48	2.0
		25	6.94	200		26.2		52	2.3
		30	8.33	180		29.4		50	2.6
	5	15	4.17	279		23.7	45	48	2.0
		25	6.94	250		32.7		52	2.3
		30	8.33	225		36.7		50	2.6
	6	15	4.17	334		28.4	55	48	2.0
		25	6.94	300		39.3		52	2.3
		30	8.33	270		44.1		50	2.6
	7	15	4.17	389		33.1	55	48	2.0
		25	6.94	350		45.8		52	2.3
		30	8.33	315		51.5		50	2.6
	8	15	4.17	414		32.8	75	48	2.0
		25	6.94	400		52.4		52	2.3
		30	8.33	360		58.8		50	2.6
	9	15	4.17	499		42.5	75	48	2.0
		25	6.94	450		58.9		52	2.3
		30	8.33	405		66.2		50	2.6
	10	15	4.17	554		47.2	90	48	2.0
		25	6.94	500		65.5		52	2.3
		30	8.33	450		73.5		50	2.6
	11	15	4.17	609		51.8	90	48	2.0
		25	6.94	550		72.0		52	2.3
		30	8.33	495		80.9		50	2.6
	12	15	4.17	664		56.7	110	48	2.0
		25	6.94	600		78.5		52	2.3
		30	8.33	504		88.2		50	2.6

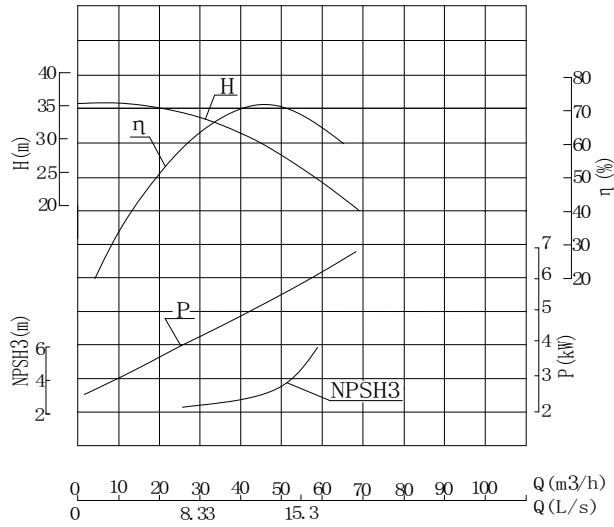

泵的型号	级数	流量 Q		扬程 H (m)	转速 n (r/min)	功率 P (kW)		效率 η (%)	必需汽蚀余量 NPSHR (m)
		(m³/h)	(L/s)			轴功率	电机功率		
MD46-30	2	30	8.33	68	2950	8.7	18.5	64	2.4
		46	12.8	60		10.6		71	3.0
		55	15.3	64		14.1		68	4.6
	3	30	8.33	102		13.0	22	64	2.4
		46	12.8	90		16.1		71	3.0
		55	15.3	81		17.8		68	4.6
	4	30	8.33	136		17.4	30	64	2.4
		46	12.8	120		21.5		71	3.0
		55	15.3	108		23.8		68	4.6
	5	30	8.33	170		21.7	37	64	2.4
		46	12.8	150		26.9		71	3.0
		55	15.3	135		29.7		68	4.6
	6	30	8.33	204		26.0	37	64	2.4
		46	12.8	180		32.2		71	3.0
		55	15.3	162		35.7		68	4.6
	7	30	8.33	238		30.4	45	64	2.4
		46	12.8	210		37.6		71	3.0
		55	15.3	189		41.6		68	4.6
	8	30	8.33	274		34.7	55	64	2.4
		46	12.8	240		43.0		71	3.0
		55	15.3	216		47.6		68	4.6
	9	30	8.33	306		39.1	55	64	2.4
		46	12.8	270		48.3		71	3.0
		55	15.3	243		53.5		68	4.6
	10	30	8.33	340		43.4	75	64	2.4
		46	12.8	300		53.7		71	3.0
		55	15.3	270		59.5		68	4.6
	11	30	8.33	374		47.8	75	64	2.4
		46	12.8	330		58.3		71	3.0
		55	15.3	297		65.5		68	4.6
	12	30	8.33	408		52.1	90	64	2.4
		46	12.8	360		63.6		71	3.0
		55	15.3	324		71.4		68	4.6

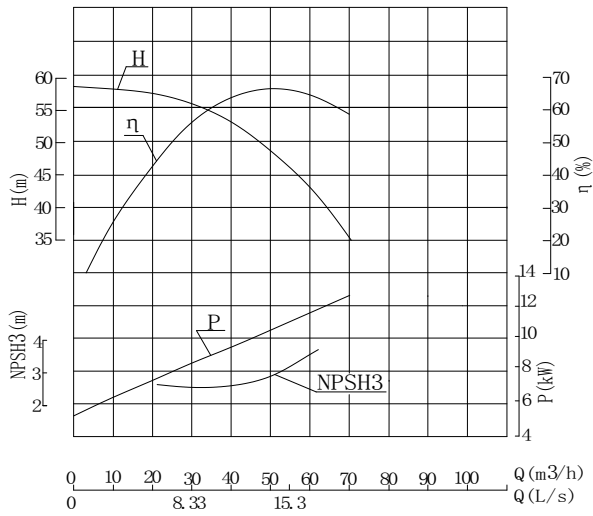

泵的型号	级数	流量 Q		扬程 H (m)	转速 n (r/min)	功率 P (kW)		效率 η (%)	必需汽蚀余量 NPSHR (m)
		(m³/h)	(L/s)			轴功率	电机功率		
MD46-50	2	30	8.33	111	2950	16.8	30	54	2.5
		46	12.8	100		19.9		63	2.8
		55	15.3	92		21.5		64	3.2
	3	30	8.33	166.5		25.2	37	54	2.5
		46	12.8	150		29.8		63	2.8
		55	15.3	138		32.3		64	3.2
	4	30	8.33	222		33.6	45	54	2.5
		46	12.8	200		39.8		63	2.8
		55	15.3	184		43.1		64	3.2
	5	30	8.33	277.5		42.0	55	54	2.5
		46	12.8	250		49.7		63	2.8
		55	15.3	230		53.4		64	3.2
	6	30	8.33	333		50.4	75	54	2.5
		46	12.8	300		59.7		63	2.8
		55	15.3	276		64.6		64	3.2
	7	30	8.33	388.5		58.8	75	54	2.5
		46	12.8	350		69.6		63	2.8
		55	15.3	322		75.4		64	3.2
	8	30	8.33	440		67.2	90	54	2.5
		46	12.8	400		79.5		63	2.8
		55	15.3	368		86.1		64	3.2
	9	30	8.33	499.5		75.6	110	54	2.5
		46	12.8	450		89.5		63	2.8
		55	15.3	414		96.9		64	3.2
	10	30	8.33	555		84.0	110	54	2.5
		46	12.8	500		99.4		63	2.8
		55	15.3	460		107.7		64	3.2
	11	30	8.33	610.5		92.4	132	54	2.5
		46	12.8	550		109.4		63	2.8
		55	15.3	506		118.4		64	3.2
	12	30	8.33	666		100.8	132	54	2.5
		46	12.8	600		119.3		63	2.8
		55	15.3	552		129.9		64	3.2

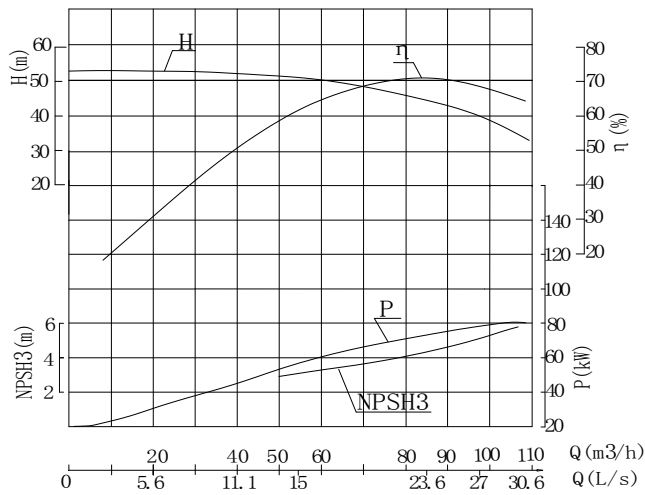

泵的型号	级数	流量 Q		扬程 H (m)	转速 n (r/min)	功率 P (kW)		效率 η (%)	必需汽蚀余量 NPSHR (m)
		(m³/h)	(L/s)			轴功率	电机功率		
MD85-45	2	54	15	100	2950	24.3	37	62	2.9
		85	23.6	90		28.9		70	4.6
		97	27	80		30.4		68	5.5
	3	54	15	150		36.4	55	62	2.9
		85	23.6	135		43.4		70	4.6
		97	27	120		45.3		68	5.5
	4	54	15	200		48.5	75	62	2.9
		85	23.6	180		57.9		70	4.6
		97	27	160		60.7		68	5.5
	5	54	15	250		60.6	90	62	2.9
		85	23.6	225		72.3		70	4.6
		97	27	200		75.9		68	5.5
	6	54	15	300		72.8	110	62	2.9
		85	23.6	270		86.8		70	4.6
		97	27	240		91.0		68	5.5
	7	54	15	350		84.9	132	62	2.9
		85	23.6	315		101.3		70	4.6
		97	27	280		106.2		68	5.5
	8	54	15	400		97.0	132	62	2.9
		85	23.6	360		115.7		70	4.6
		97	27	320		121.4		68	5.5
	9	54	15	450		109.1	160	62	2.9
		85	23.6	405		130.2		70	4.6
		97	27	360		136.6		68	5.5
	10	54	15	500		118.7	200	62	2.9
		85	23.6	450		148.9		70	4.6
		97	27	400		155.5		68	5.5
	11	54	15	550		130.5	200	62	2.9
		85	23.6	495		163.8		70	4.6
		97	27	440		171.0		68	5.5
	12	54	15	600		142.4	220	62	2.9
		85	23.6	540		178.7		70	4.6
		97	27	480		186.6		68	5.5

MD85-67 型煤矿用耐磨多级离心泵性能曲线表 (n=2950r/min)

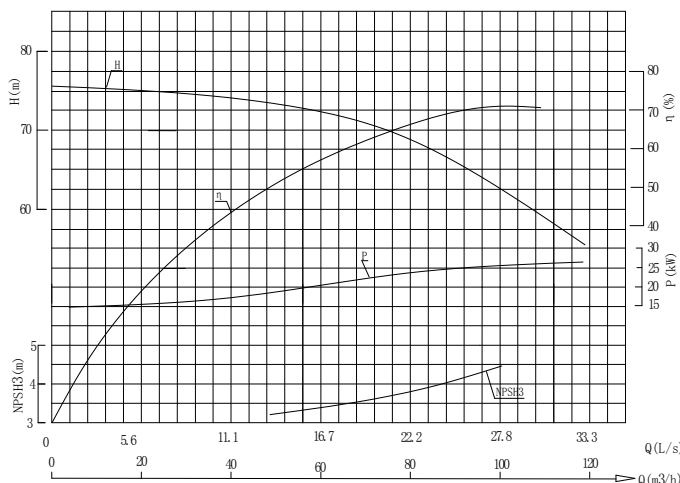

泵的型号	级数	流量 Q		扬程 H (m)	转速 n (r/min)	功率 P (kW)		效率 η (%)	必需汽蚀余量 NPSHR (m)
		(m³/h)	(L/s)			轴功率	电机功率		
MD85-67	2	55	15.28	148	2950	38.9	75	57	3.3
		85	23.61	134		47.0		66	4.0
		100	27.78	122		48.9		68	4.4
	3	55	15.28	222		57.8	90	57	3.3
		85	23.61	201		69.4		66	4.0
		100	27.78	183		75.6		68	4.4
	4	55	15.28	296		77.0	110	57	3.3
		85	23.61	268		92.2		66	4.0
		100	27.78	244		100.9		68	4.4
	5	55	15.28	370		96.3	132	57	3.3
		85	23.61	335		114.7		66	4.0
		100	27.78	305		126.2		68	4.4
	6	55	15.28	444		115.6	160	57	3.3
		85	23.61	402		138.9		66	4.0
		100	27.78	366		151.4		68	4.4
	7	55	15.28	518		134.0	200	57	3.3
		85	23.61	469		159.6		66	4.0
		100	27.78	427		172.0		68	4.4
	8	55	15.28	592		154.0	220	57	3.3
		85	23.61	536		182.4		66	4.0
		100	27.78	488		201.0		68	4.4
	9	55	15.28	666		173.3	250	57	3.3
		85	23.61	603		205.2		66	4.0
		100	27.78	549		227.1		68	4.4
	10	55	15.28	740		194.6	280	57	3.3
		85	23.61	670		235.1		66	4.0
		100	27.78	610		244.4		68	4.4
	11	55	15.28	814		214.0	315	57	3.3
		85	23.61	737		258.6		66	4.0
		100	27.78	671		268.9		68	4.4
	12	55	15.28	880		231.4	355	57	3.3
		85	23.61	804		282.1		66	4.0
		100	27.78	732		293.3		68	4.4

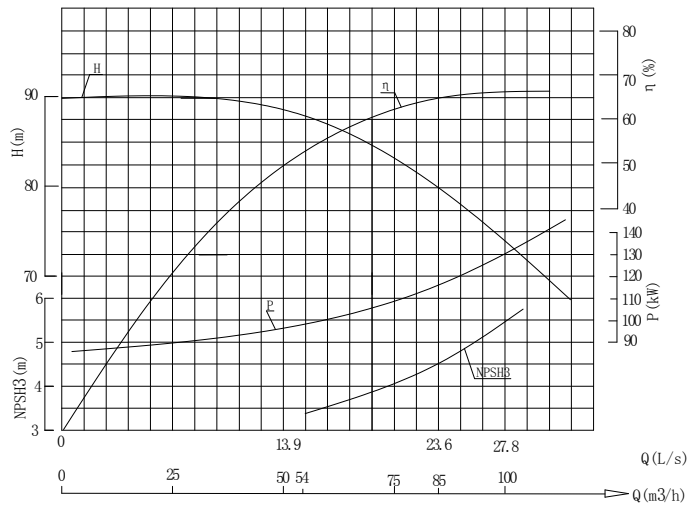

泵的类型	级数	流量 Q		扬程 H (m)	转速 n (r/min)	功率 P (kW)		效率 η (%)	必需汽蚀余量 NPSHR (m)
		(m³/h)	(L/s)			轴功率	电机功率		
MD85-80	2	54	15	176	2980	48.5	90	53	3.4
		85	23	160		55.7		65	4.5
		108	27	140		58.7		66	5.3
	3	54	15	264		73	110	53	3.4
		85	23	240		84.5		65	4.5
		108	27	210		90.8		66	5.3
	4	54	15	352		97.5	160	53	3.4
		85	23	320		113.3		65	4.5
		108	27	280		122.9		66	5.3
	5	54	15	440		122	200	53	3.4
		85	23	400		142.1		65	4.5
		108	27	350		155		66	5.3
	6	54	15	528		146.5	220	53	3.4
		85	23	480		170.9		65	4.5
		108	27	420		187.1		66	5.3
	7	54	15	616		170.9	250	53	3.4
		85	23	560		199.3		65	4.5
		108	27	490		218.4		66	5.3
	8	54	15	704		195.3	280	53	3.4
		85	23	640		227.8		65	4.5
		108	27	560		249.7		66	5.3
	9	54	15	792		219.8	315	53	3.4
		85	23	720		256.3		65	4.5
		108	27	630		280.7		66	5.3
	10	54	15	880		244.2	355	53	3.4
		85	23	800		284.8		65	4.5
		108	27	700		311.9		66	5.3
	11	54	15	968		268.6	400	53	3.4
		85	23	880		313.2		65	4.5
		108	27	770		343		66	5.3
	12	54	15	1056		293	450	53	3.4
		85	23	960		341.7		65	4.5
		108	27	840		374.3		66	5.3



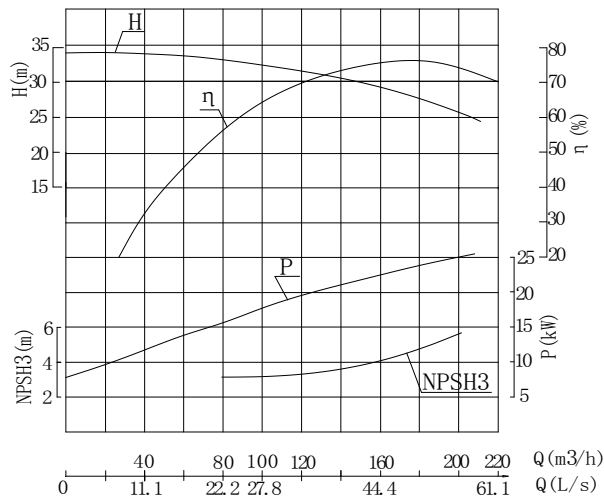

泵的型号	级数	流量 Q		扬程 H (m)	转速 n (r/min)	功率 P (kW)		效率 η (%)	必需汽蚀余量 NPSHR (m)
		(m³/h)	(L/s)			轴功率	电机功率		
MD155-30	2	100	27.8	65	1480	27.7	45	64	3.2
		155	43	60		33.8		75	3.9
		185	51.4	55		37.0		75	4.8
	3	100	27.8	97.5		41.2	75	64	3.2
		155	43	90		50.7		75	3.9
		185	51.4	82.5		55.4		75	4.8
	4	100	27.8	130		55.3	90	64	3.2
		155	43	120		67.5		75	3.9
		185	51.4	110		73.9		75	4.8
	5	100	27.8	162.5		69.2	110	64	3.2
		155	43	150		84.4		75	3.9
		185	51.4	137.5		92.4		75	4.8
	6	100	27.8	195		83.0	132	64	3.2
		155	43	180		101.3		75	3.9
		185	51.4	165		110.8		75	4.8
	7	100	27.8	227.5		96.8	160	64	3.2
		155	43	210		118.2		75	3.9
		185	51.4	192.5		129.3		75	4.8
	8	100	27.8	260		110.6	160	64	3.2
		155	43	240		135.1		75	3.9
		185	51.4	220		147.8		75	4.8
	9	100	27.8	292.5		124.5	200	64	3.2
		155	43	270		152.0		75	3.9
		185	51.4	247.5		166.3		75	4.8
	10	100	27.8	325		138.3	200	64	3.2
		155	43	300		168.8		75	3.9
		185	51.4	275		184.7		75	4.8
	11	100	27.8	357.5		152.2	220	64	3.2
		155	43	330		185.8		75	3.9
		185	51.4	302.5		203.3		75	4.8
	12	100	27.8	390		166.0	250	64	3.2
		155	43	360		202.7		75	3.9
		185	51.4	330		221.8		75	4.8

MD155-67 型煤矿用耐磨多级离心泵性能曲线表 (n=2950r/min)

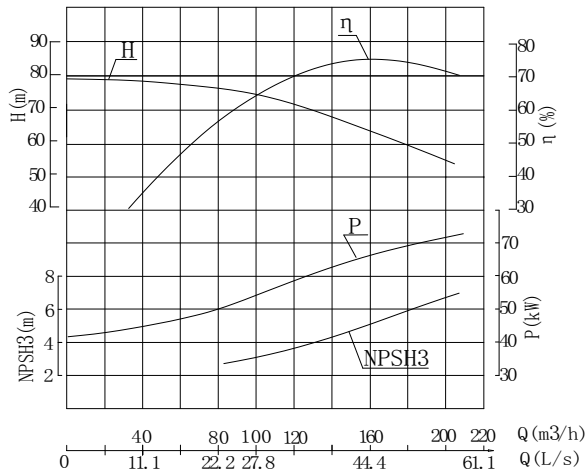

泵的类型	级数	流量 Q		扬程 H (m)	转速 n (r/min)	功率 P (kW)		效率 η (%)	必需汽蚀余量 NPSHR (m)
		(m³/h)	(L/s)			轴功率	电机功率		
MD155-67	2	100	27.8	152	2950	64.7	110	64	3.2
		155	43	134		76.5		74	5.0
		185	51.4	118		82.6		72	6.6
	3	100	27.8	228		97.0	132	64	3.2
		155	43	201		114.7		74	5.0
		185	51.4	177		123.9		72	6.6
	4	100	27.8	304		129.4	200	64	3.2
		155	43	268		152.9		74	5.0
		185	51.4	236		165.1		72	6.6
	5	100	27.8	380		161.7	220	64	3.2
		155	43	335		191.1		74	5.0
		185	51.4	295		206.4		72	6.6
	6	100	27.8	465		194.0	280	64	3.2
		155	43	402		229.3		74	5.0
		185	51.4	354		247.7		72	6.6
	7	100	27.8	532		226.4	315	64	3.2
		155	43	469		267.5		74	5.0
		185	51.4	413		289.0		72	6.6
	8	100	27.8	608		258.7	355	64	3.2
		155	43	536		405.7		74	5.0
		185	51.4	472		330.3		72	6.6
	9	100	27.8	684		291.1	450	64	3.2
		155	43	604		344.0		74	5.0
		185	51.4	531		371.6		72	6.6
	10	100	27.8	760		323.6	450	64	3.2
		155	43	670		382.4		74	5.0
		185	51.4	590		413.1		72	6.6
	11	100	27.8	836		355.9	500	64	3.2
		155	43	737		420.6		74	5.0
		185	51.4	649		454.4		72	6.6
	12	100	27.8	912		388.3	560	64	3.2
		155	43	804		458.9		74	5.0
		185	51.4	708		495.7		72	6.6

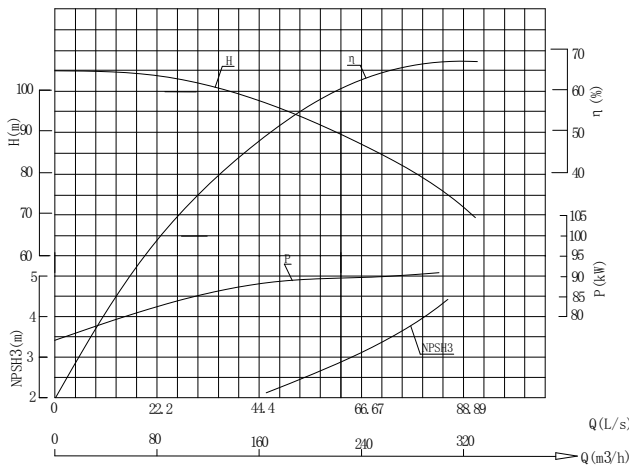

泵的型号	级数	流量 Q		扬程 H (m)	转速 n (r/min)	功率 P (kW)		效率 η (%)	必需汽蚀余量 NPSHR (m)
		(m³/h)	(L/s)			轴功率	电机功率		
MD250-85	2	185	51	192.2	1480	125.3	220	54	2.2
		250	69	170		158.0		65	3.4
		305	85	150.2		189.8		69	4.3
	3	185	51	288.3		188.0	355	54	2.2
		250	69	255		237.0		65	3.4
		305	85	225.3		284.7		69	4.3
	4	185	51	384		250.6	450	54	2.2
		250	69	340		316.0		65	3.4
		305	85	300.4		379.6		69	4.3
	5	185	51	480		313.3	560	54	2.2
		250	69	425		395.0		65	3.4
		305	85	375.5		474.6		69	4.3
	6	185	51	576.6		375.9	710	54	2.2
		250	69	510		474.0		65	3.4
		305	85	450.6		569.3		69	4.3
	7	185	51	672.7		438.6	800	54	2.2
		250	69	595		553.0		65	3.4
		305	85	525.7		664.2		69	4.3
	8	185	51	768.8		501.2	900	54	2.2
		250	69	680		632.0		65	3.4
		305	85	600.8		759.1		69	4.3
	9	185	51	864.9		563.9	1000	54	2.2
		250	69	765		711.0		65	3.4
		305	85	675.9		854.0		69	4.3
	10	185	51	961		626.5	1120	54	2.2
		250	69	850		790.0		65	3.4
		305	85	751		948.9		69	4.3
	11	185	51	1057		689.2	1250	54	2.2
		250	69	935		869.0		65	3.4
		305	85	826.1		1044.1		69	4.3
	12	185	51	1153		751.8	1250	54	2.2
		250	69	1020		948.0		65	3.4
		305	85	901.2		1138.7		69	4.3

JIN ZHOU DA YANG BEGN YE 锦州大洋泵业制造有限公司  
 MD280-43 型煤矿用耐磨多级离心泵性能曲线表 (n=1480r/min)

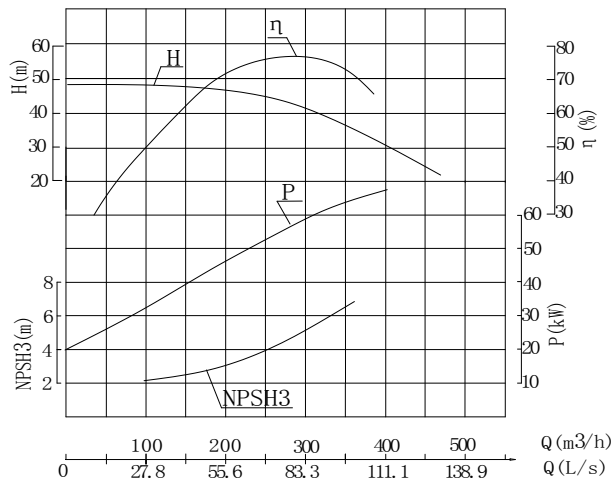

泵的型号	级数	流量 Q		扬程 H (m)	转速 n (r/min)	功率 P (kW)		效率 η (%)	必需汽蚀余量 NPSHR (m)
		(m³/h)	(L/s)			轴功率	电机功率		
MD280-43	2	185	51.4	94	1480	68.6	110	54	3.0
		280	77.8	86		85.2		65	4.7
		335	93.1	76		92.4		69	6.0
	3	185	51.4	141		103.0	160	54	3.0
		280	77.8	129		127.7		65	4.7
		335	93.1	114		138.7		69	6.0
	4	185	51.4	188		137.3	200	54	3.0
		280	77.8	172		170.3		65	4.7
		335	93.1	152		184.9		69	6.0
	5	185	51.4	235		171.6	250	54	3.0
		280	77.8	215		212.9		65	4.7
		335	93.1	190		231.1		69	6.0
	6	185	51.4	282		205.9	315	54	3.0
		280	77.8	258		255.5		65	4.7
		335	93.1	228		277.3		69	6.0
	7	185	51.4	329		240.2	355	54	3.0
		280	77.8	301		298.1		65	4.7
		335	93.1	266		323.6		69	6.0
	8	185	51.4	376		274.5	400	54	3.0
		280	77.8	344		340.7		65	4.7
		335	93.1	304		369.8		69	6.0
	9	185	51.4	423		308.9	450	54	3.0
		280	77.8	387		383.2		65	4.7
		335	93.1	342		416.0		69	6.0
	10	185	51.4	470		438.7	560	54	3.0
		280	77.8	430		504.7		65	4.7
		335	93.1	380		502.7		69	6.0
	11	185	51.4	517		482.6	630	54	3.0
		280	77.8	473		555.2		65	4.7
		335	93.1	418		553.0		69	6.0
	12	185	51.4	564		526.5	710	54	3.0
		280	77.8	516		605.7		65	4.7
		335	93.1	456		603.3		69	6.0

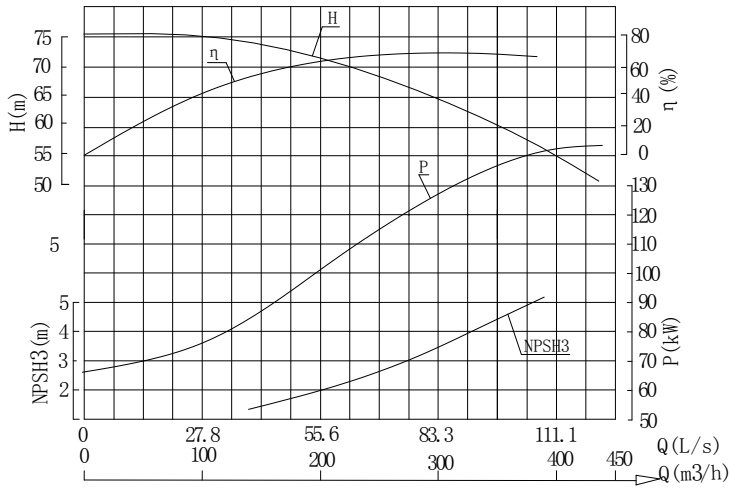

泵的型号	级数	流量 Q		扬程 H (m)	转速 n (r/min)	功率 P (kW)		效率 η (%)	必需汽蚀余量 NPSHR (m)	
		(m³/h)	(L/s)			轴功率	电机功率			
MD280-65	2	210	58.33	139.4	1480	124.6	200	64	2.2	
		280	77.8	132.5		143.6		70.4	3.4	
		340	94.44	122.8		160.2		71	4.3	
	3	210	58.33	209.1		184.2	280	251.1	64	2.2
		280	77.8	198.8		240.9		70.4	3.4	
		340	94.44	184.2		240.9		71	4.3	
	4	210	58.33	278.8		245.6	355	236.8	64	2.2
		280	77.8	265		321.2		70.4	3.4	
		340	94.44	245.6		321.2		71	4.3	
	5	210	58.33	348.5		307.0	450	307.0	64	2.2
		280	77.8	331.3		358.6		70.4	3.4	
		340	94.44	307		401.5		71	4.3	
	6	210	58.33	428.2		368.4	500	368.4	64	2.2
		280	77.8	397.5		430.3		70.4	3.4	
		340	94.44	368.4		481.3		71	4.3	
	7	210	58.33	487.5		429.8	630	429.8	64	2.2
		280	77.8	463.8		502.0		70.4	3.4	
		340	94.44	429.8		562.1		71	4.3	
	8	210	58.33	557.6		491.2	710	491.2	64	2.2
		280	77.8	530		573.7		70.4	3.4	
		340	94.44	491.2		642.4		71	4.3	
	9	210	58.33	627.3		552.6	800	552.6	64	2.2
		280	77.8	596.3		645.4		70.4	3.4	
		340	94.44	552.6		722.7		71	4.3	
	10	210	58.33	697		614.0	900	614.0	64	2.2
		280	77.8	662.5		717.1		70.4	3.4	
		340	94.44	614		803.0		71	4.3	
	11	210	58.33	766.7		685.5	1000	685.5	64	2.2
		280	77.8	728.8		789.8		70.4	3.4	
		340	94.44	675.4		881.3		71	4.3	
	12	210	58.33	836.4		747.8	1120	747.8	64	2.2
		280	77.8	795		861.6		70.4	3.4	
		340	94.44	736.8		961.4		71	4.3	

JIN ZHOU DA YANG BEGN YE 锦州大洋泵业制造有限公司  
 MD280-80 型煤矿用耐磨多级离心泵性能曲线表 (n=1480r/min)

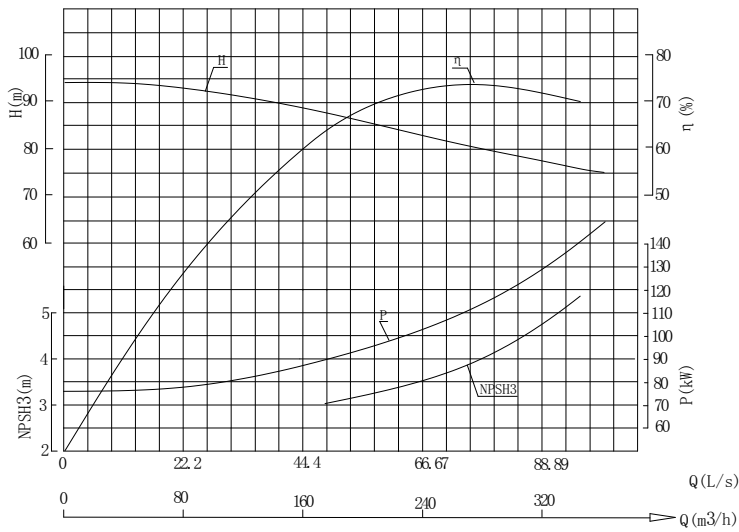

泵的型号	级数	流量 Q		扬程 H (m)	转速 n (r/min)	功率 P (kW)		效率 η (%)	必需汽蚀余量 NPSHR (m)
		(m³/h)	(L/s)			轴功率	电机功率		
MD280-80	2	175	48.6	176	1480	138.5	250	64	3.0
		280	77.8	160		174.0		74	3.9
		333	92.5	154		209.0		72	5.2
	3	210	58.33	265		207.0	355	64	3.0
		280	77.8	240		261.0		74	3.9
		340	94.44	231		314.0		72	5.2
	4	210	58.33	353		276.0	500	64	3.0
		280	77.8	320		348.0		74	3.9
		340	94.44	308		418.0		72	5.2
	5	210	58.33	441		345.0	630	64	3.0
		280	77.8	400		436.0		74	3.9
		340	94.44	386		523.0		72	5.2
	6	210	58.33	532		415.0	710	64	3.0
		280	77.8	480		523.0		74	3.9
		340	94.44	463		628.0		72	5.2
	7	210	58.33	621		485.0	800	64	3.0
		280	77.8	560		610.0		74	3.9
		340	94.44	540		628.0		72	5.2
	8	210	58.33	710		554.0	900	64	3.0
		280	77.8	640		697.0		74	3.9
		340	94.44	617		837.0		72	5.2
	9	210	58.33	796		622.0	1120	64	3.0
		280	77.8	720		784.0		74	3.9
		340	94.44	692		939.0		72	5.2
	10	210	58.33	882		689.0	1120	64	3.0
		280	77.8	800		871.0		74	3.9
		340	94.44	771		1045.0		72	5.2
	11	210	58.33	976		762.0	1250	64	3.0
		280	77.8	880		958.0		74	3.9
		340	94.44	840		1150.0		72	5.2
	12	210	58.33	1065		831.0	1400	64	3.0
		280	77.8	960		1046.0		74	3.9
		340	94.44	926		1250.0		72	5.2

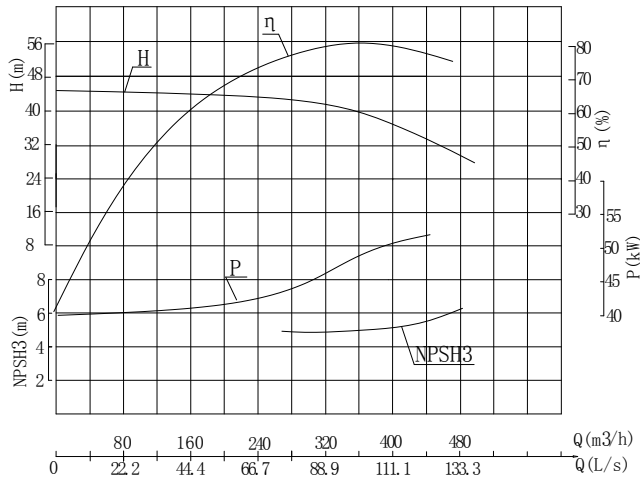

泵的型号	级数	流量 Q		扬程 H (m)	转速 n (r/min)	功率 P (kW)		效率 η (%)	必需汽蚀余量 NPSHR (m)	
		(m³/h)	(L/s)			轴功率	电机功率			
MD360-40	2	300	83.3	84	1480	89.1	132	77	4.7	
		360	100	80		98.1		80	4.7	
		400	122.2	71		110.5		77	5.4	
	3	300	83.3	126		133.7	200	147.2	77	4.7
		360	100	120		147.2		80	4.7	
		400	122.2	106.5		165.8		77	5.4	
	4	300	83.3	168		178.2	250	196.2	77	4.7
		360	100	160		196.2		80	4.7	
		400	122.2	142		221.1		77	5.4	
	5	300	83.3	210		222.8	315	245.3	77	4.7
		360	100	200		245.3		80	4.7	
		400	122.2	177.5		276.3		77	5.4	
	6	300	83.3	252		257.4	400	294.1	77	4.7
		360	100	240		294.1		80	4.7	
		400	122.2	213		331.5		77	5.4	
	7	300	83.3	294		311.9	450	343.1	77	4.7
		360	100	280		343.1		80	4.7	
		400	122.2	248.5		366.7		77	5.4	
	8	300	83.3	336		356.5	500	392.2	77	4.7
		360	100	320		392.2		80	4.7	
		400	122.2	284		441.9		77	5.4	
	9	300	83.3	378		401.1	560	441.2	77	4.7
		360	100	360		441.2		80	4.7	
		400	122.2	319.5		497.2		77	5.4	
	10	300	83.3	420		445.6	630	490.2	77	4.7
		360	100	400		490.2		80	4.7	
		400	122.2	355		552.4		77	5.4	
	11	300	83.3	462		490.5	630	539.5	77	4.7
		360	100	440		539.5		80	4.7	
		400	122.2	390.5		552.8		77	5.4	
	12	300	83.3	504		535.1	710	588.6	77	4.7
		360	100	480		588.6		80	4.7	
		400	122.2	426		603.0		77	5.4	



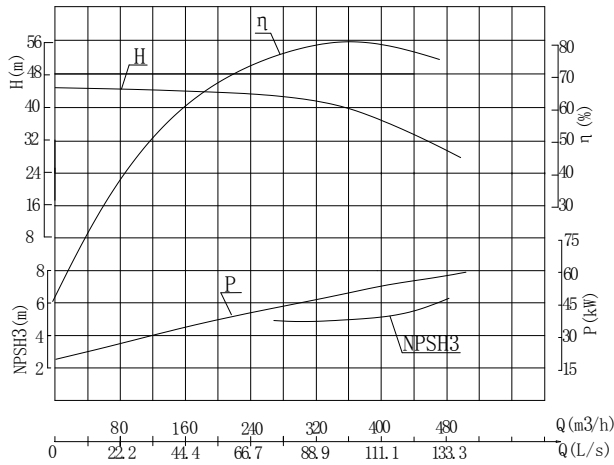

泵的型号	级数	流量 Q		扬程 H (m)	转速 n (r/min)	功率 P (kW)		效率 η (%)	必需汽蚀余量 NPSHR (m)
		(m³/h)	(L/s)			轴功率	电机功率		
MD450-60	2	335	93.1	130	1480	164.8	220	72	3.8
		450	125	120		186.3		79	4.9
		500	139	114		199.1		78	6.0
	3	335	93.1	195		247.2	355	72	3.8
		450	125	180		279.4		79	4.9
		500	139	171		298.7		78	6.0
	4	335	93.1	260		329.6	450	72	3.8
		450	125	240		372.5		79	4.9
		500	139	228		398.2		78	6.0
	5	335	93.1	325		412.0	630	72	3.8
		450	125	300		465.6		79	4.9
		500	139	285		497.8		78	6.0
	6	335	93.1	390		494.4	710	72	3.8
		450	125	360		558.8		79	4.9
		500	139	342		597.4		78	6.0
	7	335	93.1	455		576.9	800	72	3.8
		450	125	420		651.9		79	4.9
		500	139	399		696.9		78	6.0
	8	335	93.1	520		659.3	900	72	3.8
		450	125	480		745.0		79	4.9
		500	139	456		796.5		78	6.0
	9	335	93.1	585		741.7	1000	72	3.8
		450	125	540		838.1		79	4.9
		500	139	513		896.1		78	6.0
	10	335	93.1	650		824.1	1120	72	3.8
		450	125	600		931.3		79	4.9
		500	139	570		995.6		78	6.0
	11	335	93.1	715		906.5	1250	72	3.8
		450	125	660		1024.4		79	4.9
		500	139	627		1095.2		78	6.0
	12	335	93.1	780		988.9	1400	72	3.8
		450	125	720		1117.5		79	4.9
		500	139	684		1194.7		78	6.0

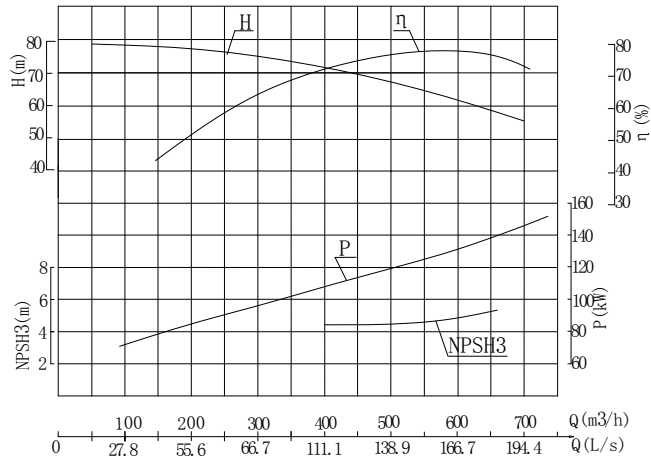

泵的型号	级数	流量 Q		扬程 H (m)	转速 n (r/min)	功率 P (kW)		效率 η (%)	必需汽蚀余量 NPSHR (m)	
		(m³/h)	(L/s)			轴功率	电机功率			
MD600-65	2	440	122	140	1480	226.8	315	74	4.2	
		600	166	130		272.5		78	4.5	
		650	180	120		279.7		76	4.9	
	3	440	122	210		340.2	500	408.7	74	4.2
		600	166	195		408.7		78	4.5	
		650	180	180		419.5		76	4.9	
	4	440	122	280		453.6	630	545.0	74	4.2
		600	166	260		545.0		78	4.5	
		650	180	240		559.3		76	4.9	
	5	440	122	350		567.1	800	681.2	74	4.2
		600	166	325		681.2		78	4.5	
		650	180	300		699.1		76	4.9	
	6	440	122	420		680.5	1000	817.5	74	4.2
		600	166	390		817.5		78	4.5	
		650	180	360		839.0		76	4.9	
	7	440	122	490		793.9	1120	953.7	74	4.2
		600	166	455		953.7		78	4.5	
		650	180	420		978.8		76	4.9	
	8	440	122	560		907.3	1250	1089.9	74	4.2
		600	166	520		1089.9		78	4.5	
		650	180	480		1118.6		76	4.9	
	9	440	122	630		1020.7	1400	1226.2	74	4.2
		600	166	585		1226.2		78	4.5	
		650	180	540		1258.4		76	4.9	
	10	440	122	700		1134.1	1600	1362.4	74	4.2
		600	166	650		1362.4		78	4.5	
		650	180	600		1398.3		76	4.9	
	11	440	122	770		1247.5	1800	1498.7	74	4.2
		600	166	715		1498.7		78	4.5	
		650	180	660		1538.1		76	4.9	
	12	440	122	840		1360.9	2000	1634.9	74	4.2
		600	166	780		1634.9		78	4.5	
		650	180	720		1677.9		76	4.9	

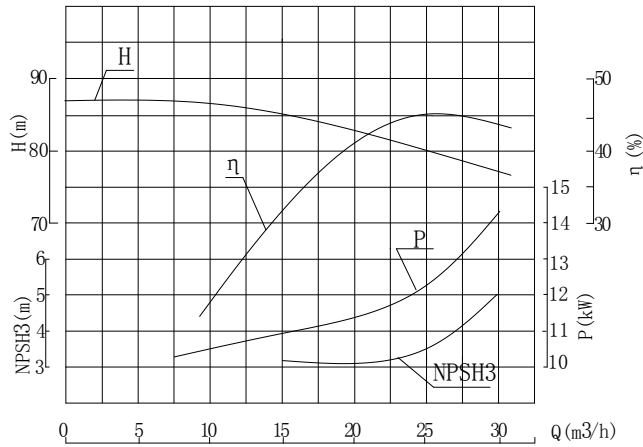

泵的型号	级数	流量 Q		扬程 H (m)	转速 n (r/min)	功率 P (kW)		效率 η (%)	必需汽蚀余量 NPSHR (m)
		(m³/h)	(L/s)			轴功率	电机功率		
MD25-80	2	15	4.2	173	2980	22.1	37	32	3.2
		25	6.9	160		24.2		45	3.5
		30	8.3	156		29.0		44	5.0
	3	15	4.2	259.5		33.1	55	32	3.2
		25	6.9	240		36.3		45	3.5
		30	8.3	234		43.5		44	5.0
	4	15	4.2	346.4		44.2	75	32	3.2
		25	6.9	320		48.4		45	3.5
		30	8.3	312		58.0		44	5.0
	5	15	4.2	433		55.3	90	32	3.2
		25	6.9	400		60.6		45	3.5
		30	8.3	390		72.5		44	5.0
	6	15	4.2	520		66.4	90	32	3.2
		25	6.9	480		72.7		45	3.5
		30	8.3	470		87.3		44	5.0
	7	15	4.2	607		77.5	110	32	3.2
		25	6.9	560		84.8		45	3.5
		30	8.3	546		101.4		44	5.0
	8	15	4.2	693		88.5	132	32	3.2
		25	6.9	640		96.9		45	3.5
		30	8.3	624		115.9		44	5.0
	9	15	4.2	780		99.6	132	32	3.2
		25	6.9	720		109.0		45	3.5
		30	8.3	707		131.3		44	5.0
	10	15	4.2	866		110.6	160	32	3.2
		25	6.9	800		121.1		45	3.5
		30	8.3	780		144.9		44	5.0
	11	15	4.2	953		121.7	200	32	3.2
		25	6.9	880		133.2		45	3.5
		30	8.3	858		159.4		44	5.0
	12	15	4.2	1039		132.7	200	32	3.2
		25	6.9	960		145.3		45	3.5
		30	8.3	936		173.9		44	5.0

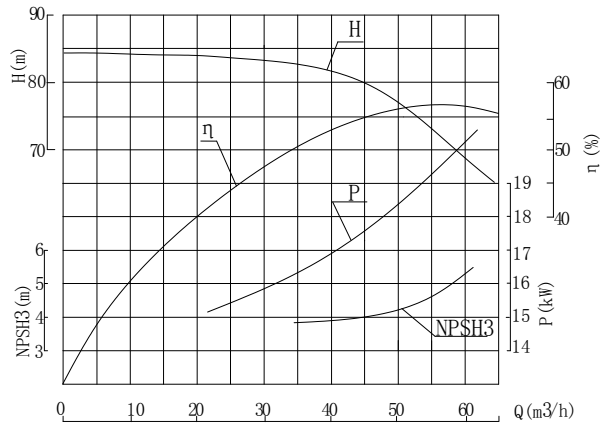

泵型号	级数	流量 Q		扬程 H (m)	转速 n (r/min)	功率 P (kW)		效率 η (%)	必需汽蚀余量 NPSHR (m)
		(m³/h)	(L/s)			轴功率	电机功率		
MD45-80	2	36	10.0	167.2	2980	32.8	55	50	3.9
		45	12.5	160		35.7		55	4.0
		62	17.2	136.4		41.1		56	5.5
	3	36	10.0	250.8		49.2	90	50	3.9
		45	12.5	240		53.5		55	4.0
		62	17.2	204.6		61.7		56	5.5
	4	36	10.0	334.4		65.6	110	50	3.9
		45	12.5	320		71.3		55	4.0
		62	17.2	272.8		82.3		56	5.5
	5	36	10.0	418		82.0	132	50	3.9
		45	12.5	400		89.2		55	4.0
		62	17.2	341		102.9		56	5.5
	6	36	10.0	502		98.5	132	50	3.9
		45	12.5	480		107.0		55	4.0
		62	17.2	409		123.4		56	5.5
	7	36	10.0	753		147.7	160	50	3.9
		45	12.5	560		124.8		55	4.0
		62	17.2	477		143.9		56	5.5
	8	36	10.0	669		131.2	200	50	3.9
		45	12.5	640		142.7		55	4.0
		62	17.2	545		164.4		56	5.5
	9	36	10.0	735		144.2	200	50	3.9
		45	12.5	720		160.5		55	4.0
		62	17.2	613.6		185.1		56	5.5
	10	36	10.0	836.6		164.1	250	50	3.9
		45	12.5	800		178.4		55	4.0
		62	17.2	681.8		205.7		56	5.5
	11	36	10.0	920		180.5	250	50	3.9
		45	12.5	880		196.2		55	4.0
		62	17.2	750		226.3		56	5.5
	12	36	10.0	1004		197.0	280	50	3.9
		45	12.5	960		214.0		55	4.0
		62	17.2	818		246.8		56	5.5

MD80-120 型煤矿用耐磨多级离心泵性能曲线表 (n=2980r/min)

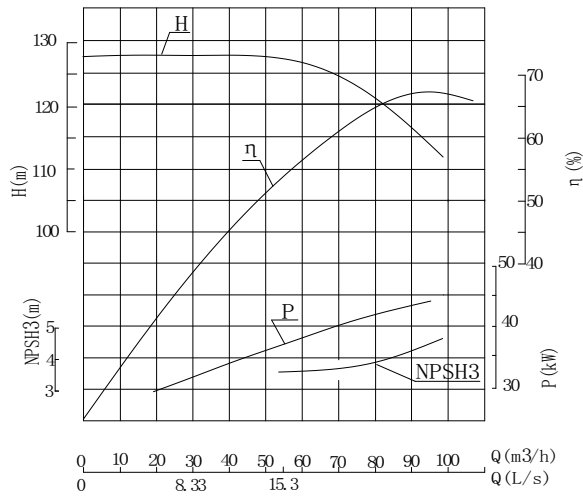

泵的型号	级数	流量 Q		扬程 H (m)	转速 n (r/min)	功率 P (kW)		效率 η (%)	必需汽蚀余量 NPSHR (m)
		(m³/h)	(L/s)			轴功率	电机功率		
MD80-120	2	56	15.56	254	2980	73.1	132	53	3.6
		80	22.22	240		84.4		62	3.8
		96	26.67	226		88.2		67	4.5
	3	56	15.56	381		109.7	160	53	3.6
		80	22.22	360		126.6		62	3.8
		96	26.67	339		132.4		67	4.5
	4	56	15.56	508		146.3	200	53	3.6
		80	22.22	480		168.8		62	3.8
		96	26.67	452		176.5		67	4.5
	5	56	15.56	635		182.8	250	53	3.6
		80	22.22	600		211.0		62	3.8
		96	26.67	565		220.6		67	4.5
	6	56	15.56	762		219.4	315	53	3.6
		80	22.22	720		253.1		62	3.8
		96	26.67	678		264.7		67	4.5
	7	56	15.56	889		255.9	355	53	3.6
		80	22.22	840		295.3		62	3.8
		96	26.67	791		308.8		67	4.5
	8	56	15.56	1016		292.5	400	53	3.6
		80	22.22	960		337.5		62	3.8
		96	26.67	904		352.9		67	4.5
	9	56	15.56	1143		329.1	450	53	3.6
		80	22.22	1080		379.7		62	3.8
		96	26.67	1017		397.1		67	4.5
	10	56	15.56	1270		365.6	500	53	3.6
		80	22.22	1200		421.9		62	3.8
		96	26.67	1130		441.2		67	4.5
	11	56	15.56	1397		402.2	560	53	3.6
		80	22.22	1320		464.1		62	3.8
		96	26.67	1243		485.3		67	4.5
	12	56	15.56	1524		438.8	630	53	3.6
		80	22.22	1440		506.3		62	3.8
		96	26.67	1356		529.4		67	4.5

MD160-120 型煤矿用耐磨多级离心泵性能曲线表 (n=2980r/min)

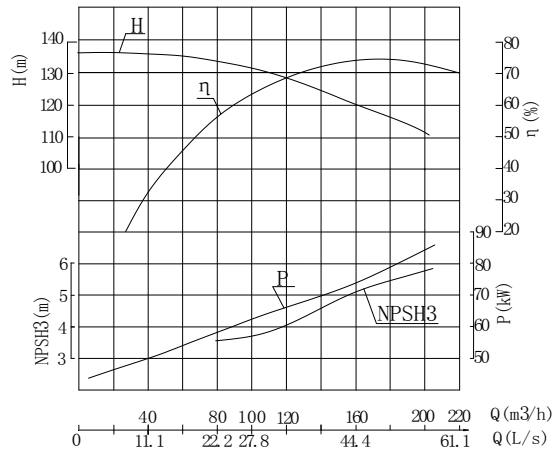

泵的型号	级数	流量 Q		扬程 H (m)	转速 n (r/min)	功率 P (kW)		效率 η (%)	必需汽蚀余量 NPSHR (m)
		(m³/h)	(L/s)			轴功率	电机功率		
MD160-120	2	112	31.11	270	2980	129.76	200	63.5	3.8
		160	44.44	240		145.32		72	5.2
		192	53.33	228		165.21		72.2	5.8
	3	112	31.11	405		194.64	280	63.5	3.8
		160	44.44	360		217.99		72	5.2
		192	53.33	342		247.82		72.2	5.8
	4	112	31.11	540		259.52	400	63.5	3.8
		160	44.44	480		290.65		72	5.2
		192	53.33	456		330.42		72.2	5.8
	5	112	31.11	675		324.41	450	63.5	3.8
		160	44.44	600		363.31		72	5.2
		192	53.33	570		413.03		72.2	5.8
	6	112	31.11	810		389.29	560	63.5	3.8
		160	44.44	720		435.97		72	5.2
		192	53.33	684		495.63		72.2	5.8
	7	112	31.11	945		454.17	630	63.5	3.8
		160	44.44	840		508.64		72	5.2
		192	53.33	798		578.24		72.2	5.8
	8	112	31.11	1080		519.05	710	63.5	3.8
		160	44.44	960		581.30		72	5.2
		192	53.33	912		660.84		72.2	5.8
	9	112	31.11	1218		585.37	800	63.5	3.8
		160	44.44	1080		653.96		72	5.2
		192	53.33	1025		742.73		72.2	5.8
	10	112	31.11	1353		650.25	900	63.5	3.8
		160	44.44	1200		726.62		72	5.2
		192	53.33	1138		824.61		72.2	5.8
	11	112	31.11	1489		715.62	1000	63.5	3.8
		160	44.44	1320		799.29		72	5.2
		192	53.33	1252		907.21		72.2	5.8
	12	112	31.11	1624		780.50	1120	63.5	3.8
		160	44.44	1440		871.95		72	5.2
		192	53.33	1366		989.82		72.2	5.8
	13	112	31.11	1759		845.38	1250	63.5	3.8
		160	44.44	1560		944.61		72	5.2
		192	53.33	1480		1072.44		72.2	5.8

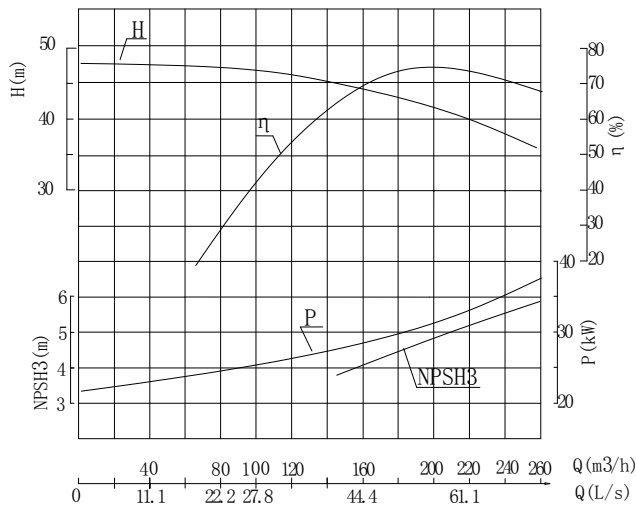

泵的型号	级数	流量 Q		扬程 H (m)	转速 n (r/min)	功率 P (kW)		效率 η (%)	必需汽蚀余量 NPSHR (m)
		(m³/h)	(L/s)			轴功率	电机功率		
MD220-40	2	145	40.28	90	1480	56.4	110	63	3.8
		220	61.11	80		66.6		72	5.2
		259	71.94	72		74.7		68	5.8
	3	145	40.28	135		84.7	132	63	3.8
		220	61.11	120		99.9		72	5.2
		259	71.94	108		112.1		68	5.8
	4	145	40.28	180		112.9	200	63	3.8
		220	61.11	160		133.2		72	5.2
		259	71.94	144		149.4		68	5.8
	5	145	40.28	225		141.1	200	63	3.8
		220	61.11	200		166.5		72	5.2
		259	71.94	180		186.8		68	5.8
	6	145	40.28	270		169.3	250	63	3.8
		220	61.11	240		199.8		72	5.2
		259	71.94	216		224.2		68	5.8
	7	145	40.28	315		197.6	315	63	3.8
		220	61.11	280		233.1		72	5.2
		259	71.94	252		261.5		68	5.8
	8	145	40.28	360		225.8	355	63	3.8
		220	61.11	320		266.4		72	5.2
		259	71.94	288		298.9		68	5.8
	9	145	40.28	405		254.0	400	63	3.8
		220	61.11	360		299.7		72	5.2
		259	71.94	324		336.3		68	5.8
	10	145	40.28	450		282.2	450	63	3.8
		220	61.11	400		333.0		72	5.2
		259	71.94	360		373.6		68	5.8
	11	145	40.28	495		310.4	450	63	3.8
		220	61.11	440		366.3		72	5.2
		259	71.94	396		411.0		68	5.8
	12	145	40.28	540		338.7	500	63	3.8
		220	61.11	480		399.6		72	5.2
		259	71.94	432		448.3		68	5.8

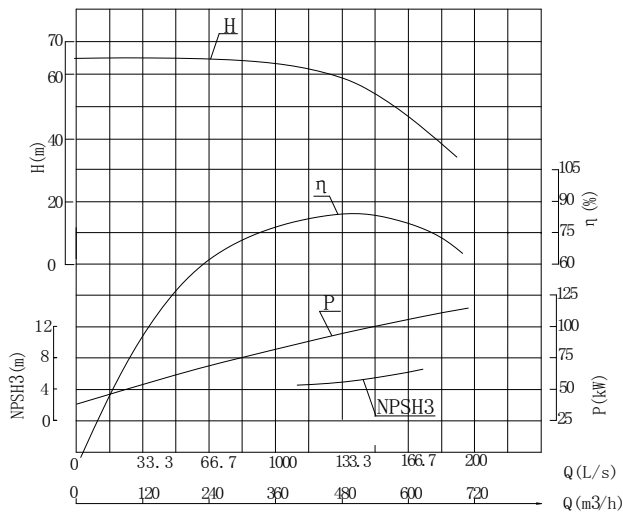

泵的型号	级数	流量 Q		扬程 H (m)	转速 n (r/min)	功率 P (kW)		效率 η (%)	必需汽蚀余量 NPSHR (m)
		(m³/h)	(L/s)			轴功率	电机功率		
MD500-57	2	450	125	120	1480	183.9	250	80	4.4
		500	138.89	114		191.7		81	5.0
		550	152.78	108		204.9		79	5.8
	3	450	125	180		275.9	355	80	4.4
		500	138.89	171		287.6		81	5.0
		550	152.78	162		307.3		79	5.8
	4	450	125	240		367.9	500	80	4.4
		500	138.89	228		383.5		81	5.0
		550	152.78	216		409.8		79	5.8
	5	450	125	300		459.8	630	80	4.4
		500	138.89	285		479.4		81	5.0
		550	152.78	270		512.2		79	5.8
	6	450	125	360		551.8	710	80	4.4
		500	138.89	342		575.2		81	5.0
		550	152.78	324		614.6		79	5.8
	7	450	125	420		643.7	800	80	4.4
		500	138.89	399		671.1		81	5.0
		550	152.78	378		717.1		79	5.8
	8	450	125	480		735.7	1000	80	4.4
		500	138.89	456		767.0		81	5.0
		550	152.78	432		819.5		79	5.8
	9	450	125	540		827.7	1120	80	4.4
		500	138.89	513		862.9		81	5.0
		550	152.78	486		922.0		79	5.8
10	450	125	600	919.6	1250	80	4.4		
	500	138.89	570	958.7		81	5.0		
	550	152.78	540	1024.4		79	5.8		
11	450	125	660	1011.6	1250	80	4.4		
	500	138.89	627	1054.6		81	5.0		
	550	152.78	594	1126.8		79	5.8		
12	450	125	720	1103.6	1400	80	4.4		
	500	138.89	684	1150.5		81	5.0		
	550	180	648	1229.28		79	5.8		



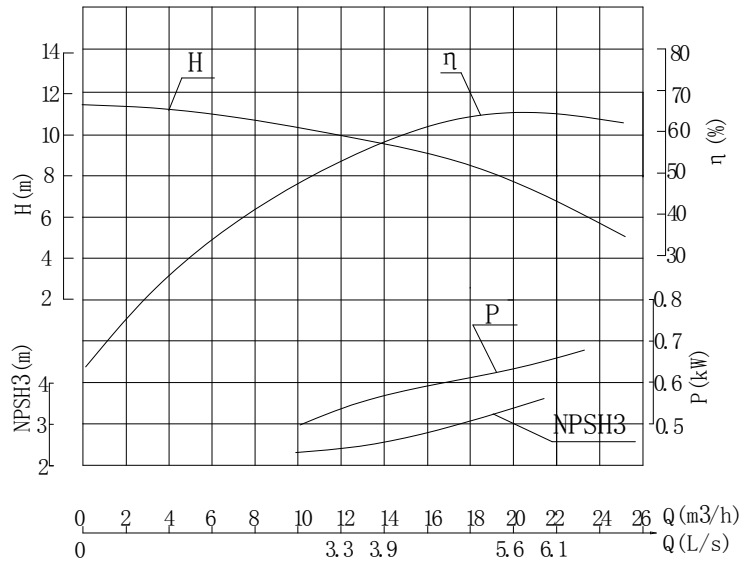

泵的型号	级数	流量 Q		扬程 H (m)	转速 n (r/min)	功率 P (kW)		效率 η (%)	必需汽蚀余量 NPSHR (m)
		(m³/h)	(L/s)			轴功率	电机功率		
50MD8	2	12.6	3.5	19.4	2950	1.21	2.2	55	2.7
		18	5	17		1.29		64.5	3.1
		21.6	6	14.6		1.32		65	3.5
	3	12.6	3.5	29.1		1.82	2.2	55	2.7
		18	5	25.5		1.94		64.5	3.1
		21.6	6	21.9		1.98		65	3.5
	4	12.6	3.5	38.8		2.42	3	55	2.7
		18	5	34		2.59		64.5	3.1
		21.6	6	29.2		2.64		65	3.5
	5	12.6	3.5	48.5		3.03	4	55	2.7
		18	5	42.5		3.23		64.5	3.1
		21.6	6	36.5		3.31		65	3.5
	6	12.6	3.5	58.2		3.63	5.5	55	2.7
		18	5	51		3.88		64.5	3.1
		21.6	6	43.8		3.97		65	3.5
	7	12.6	3.5	67.9		4.24	5.5	55	2.7
		18	5	59.5		4.52		64.5	3.1
		21.6	6	51.1		4.63		65	3.5
	8	12.6	3.5	77.6		4.84	7.5	55	2.7
		18	5	68		5.17		64.5	3.1
		21.6	6	58.4		5.29		65	3.5
	9	12.6	3.5	87.5		5.46	7.5	55	2.7
		18	5	76.5		5.82		64.5	3.1
		21.6	6	65.7		5.95		65	3.5

80MD12 型矿用耐磨多级离心泵性能曲线表 (n=2950r/min)

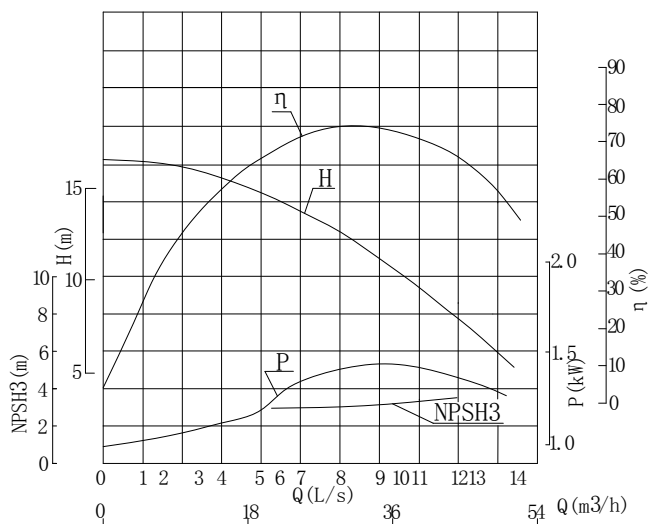

泵的型号	级数	流量 Q		扬程 H (m)	转速 n (r/min)	功率 P (kW)		效率 η (%)	必需汽蚀余量 NPSHR (m)
		(m³/h)	(L/s)			轴功率	电机功率		
80MD12	2	21.6	6	28.8	2950	2.46	4	69	2.9
		34.6	9.6	22.8		2.87		75	3.0
		39.6	11	18		2.70		72	3.1
	3	21.6	6	43.2		3.68	5.5	69	2.9
		34.6	9.6	34.2		4.30		75	3.0
		39.6	11	28.5		4.27		72	3.1
	4	21.6	6	57.6		4.91	7.5	69	2.9
		34.6	9.6	45.6		5.73		75	3.0
		39.6	11	38		5.69		72	3.1
	5	21.6	6	72		6.14	11	69	2.9
		34.6	9.6	57		7.17		75	3.0
		39.6	11	47.5		7.12		72	3.1
	6	21.6	6	86.4		7.37	11	69	2.9
		34.6	9.6	68.4		8.60		75	3.0
		39.6	11	60		8.99		72	3.1
	7	21.6	6	100.8		8.60	15	69	2.9
		34.6	9.6	79.8		10.03		75	3.0
		39.6	11	69.5		10.42		72	3.1
	8	21.6	6	115.2		9.83	15	69	2.9
		34.6	9.6	91.2		11.46		75	3.0
		39.6	11	79		11.84		72	3.1
	9	21.6	6	129.6		11.05	15	69	2.9
		34.6	9.6	102.6		12.90		75	3.0
		39.6	11	88.9		13.32		72	3.1

80MD30 型矿用耐磨多级离心泵性能曲线表 (n=2950r/min)

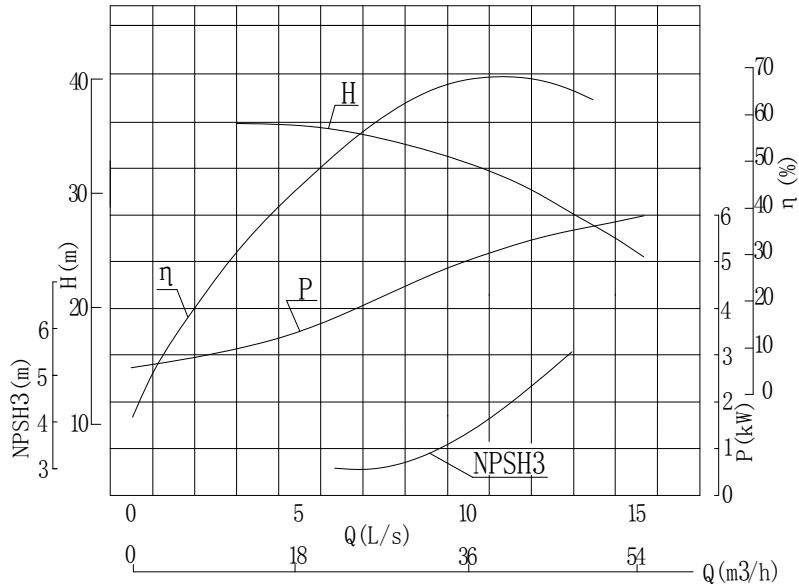

泵的型号	级数	流量 Q		扬程 H (m)	转速 n (r/min)	功率 P (kW)		效率 η (%)	必需汽蚀余量 NPSHR (m)
		(m³/h)	(L/s)			轴功率	电机功率		
80MD30	2	23	6.38	68	2950	7.82	18.5	54.5	3.0
		43	11.93	60		10.65		66	4.0
		50	13.9	53.2		11.07		65.5	5.0
	3	23	6.38	102.6		11.80	22	54.5	3.0
		43	11.93	90		15.98		66	4.0
		50	13.9	79.8		16.60		65.5	5.0
	4	23	6.38	136.8		15.73	30	54.5	3.0
		43	11.93	120		21.30		66	4.0
		50	13.9	106.4		22.13		65.5	5.0
	5	23	6.38	171		19.66	30	54.5	3.0
		43	11.93	150		26.63		66	4.0
		50	13.9	133		27.66		65.5	5.0
	6	23	6.38	205.2		23.60	37	54.5	3.0
		43	11.93	180		31.95		66	4.0
		50	13.9	159.6		33.20		65.5	5.0
	7	23	6.38	239.4		27.53	45	54.5	3.0
		43	11.93	210		37.28		66	4.0
		50	13.9	186.2		38.73		65.5	5.0
	8	23	6.38	273.6		31.46	55	54.5	3.0
		43	11.93	240		42.61		66	4.0
		50	13.9	212.8		44.26		65.5	5.0
	9	23	6.38	307.8		35.39	55	54.5	3.0
		43	11.93	270		47.93		66	4.0
		50	13.9	239.4		49.80		65.5	5.0
	10	23	6.38	342		39.33	75	54.5	3.0
		43	11.93	300		53.26		66	4.0
		50	13.9	266		55.33		65.5	5.0

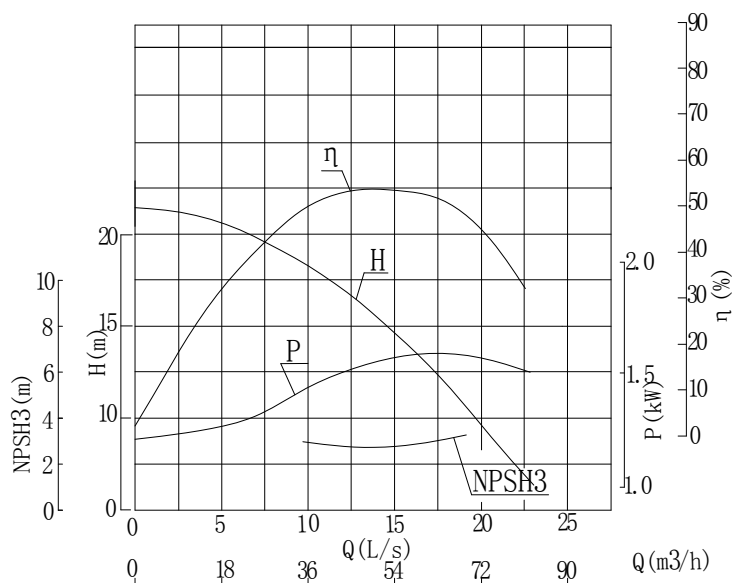

泵的类型	级数	流量 Q		扬程 H (m)	转速 n (r/min)	功率 P (kW)		效率 η (%)	必需汽蚀余量 NPSHR (m)
		(m³/h)	(L/s)			轴功率	电机功率		
100MD16	2	37.6	11	36.8	2950	5.31	7.5	71	3.0
		54	15	31		6.00		76	3.1
		72	20	20.4		6.06		66	3.4
	3	37.6	11	55.2		7.97	11	71	3.0
		54	15	46.5		9.00		76	3.1
		72	20	30.6		9.10		66	3.4
	4	37.6	11	73.6		10.62	18.5	71	3.0
		54	15	62		12.00		76	3.1
		72	20	40.8		12.13		66	3.4
	5	37.6	11	92		13.28	22	71	3.0
		54	15	77.5		15.00		76	3.1
		72	20	51		15.16		66	3.4
	6	37.6	11	110.4		15.93	22	71	3.0
		54	15	93		18.01		76	3.1
		72	20	61.2		18.19		66	3.4
	7	37.6	11	128.8		18.59	30	71	3.0
		54	15	108.5		21.01		76	3.1
		72	20	71.4		21.22		66	3.4
	8	37.6	11	147.2		21.24	30	71	3.0
		54	15	124		24.01		76	3.1
		72	20	81.6		24.26		66	3.4
	9	37.6	11	165.6		23.90	37	71	3.0
		54	15	139.5		27.01		76	3.1
		72	20	91.8		27.29		66	3.4

100MD24 型矿用耐磨多级离心泵性能曲线表 (n=2950r/min)

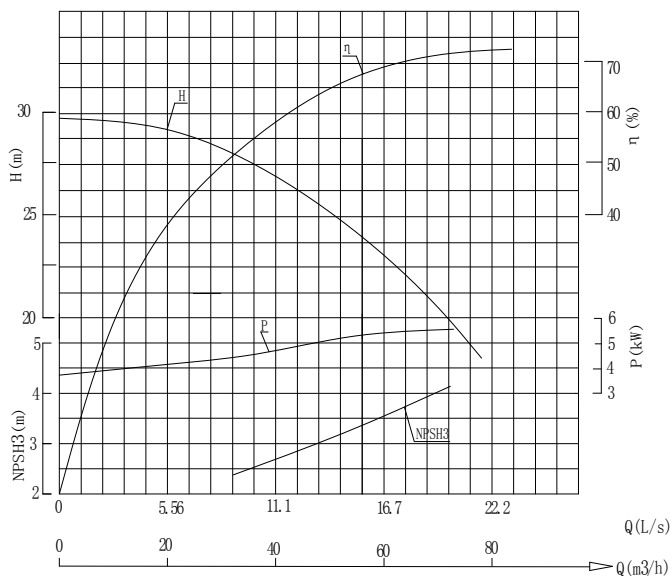

泵的型号	级数	流量 Q		扬程 H (m)	转速 n (r/min)	功率 P (kW)		效率 η (%)	必需汽蚀余量 NPSHR (m)
		(m³/h)	(L/s)			轴功率	电机功率		
100MD24	2	36	10	53	2950	9.45	15	55	2.4
		54	15	48		10.54		67	3.4
		72	20	40		11.05		71	4.1
	3	36	10	79.5		14.18	18.5	55	2.4
		54	15	72		15.81		67	3.4
		72	20	60		16.58		71	4.1
	4	36	10	106		18.91	30	55	2.4
		54	15	96		21.08		67	3.4
		72	20	80		22.11		71	4.1
	5	36	10	132.5		23.63	30	55	2.4
		54	15	120		26.35		67	3.4
		72	20	100		27.63		71	4.1
	6	36	10	159		28.36	37	55	2.4
		54	15	144		31.62		67	3.4
		72	20	120		33.16		71	4.1
	7	36	10	185		33.00	45	55	2.4
		54	15	168		36.90		67	3.4
		72	20	140		38.69		71	4.1
	8	36	10	212		37.81	55	55	2.4
		54	15	192		42.17		67	3.4
		72	20	160		44.21		71	4.1
	9	36	10	238.5		42.54	55	55	2.4
		54	15	216		47.44		67	3.4
		72	20	180		49.74		71	4.1
10	36	10	265	47.26	75	55	2.4		
	54	15	240	52.71		67	3.4		
	72	20	200	55.26		71	4.1		

100MD45 型煤矿用耐磨多级离心泵性能曲线表 (n=2950r/min)

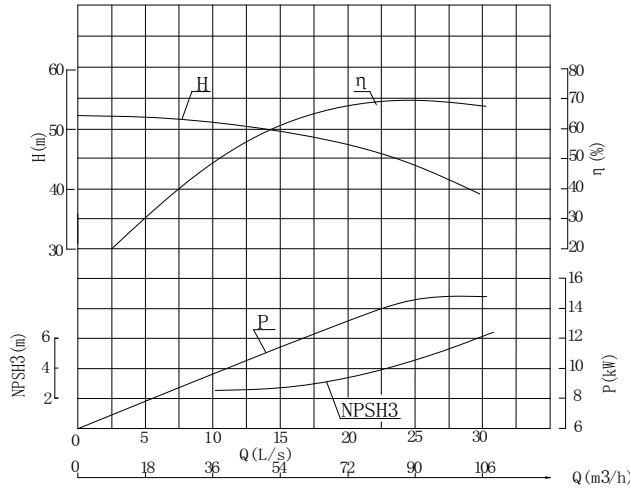

泵的型号	级数	流量 Q		扬程 H (m)	转速 n (r/min)	功率 P (kW)		效率 η (%)	必需汽蚀余量 NPSHR (m)
		(m³/h)	(L/s)			轴功率	电机功率		
100MD45	2	54	15	100	2950	23.7	37	62	2.9
		85	23.6	90		29.4		71	4.6
		97	27	80		31.1		68	5.5
	3	54	15	150		35.6	55	62	2.9
		85	23.6	135		44.0		71	4.6
		97	27	120		46.6		68	5.5
	4	54	15	200		53.5	75	55	2.9
		85	23.6	180		62.2		67	4.6
		97	27	160		59.6		71	5.5
	5	54	15	250		59.3	90	62	2.9
		85	23.6	225		73.4		71	4.6
		97	27	200		77.7		68	5.5
	6	54	15	300		71.2	110	62	2.9
		85	23.6	270		88.1		71	4.6
		97	27	240		93.3		68	5.5
	7	54	15	350		83.1	132	62	2.9
		85	23.6	315		102.8		71	4.6
		97	27	280		108.8		68	5.5
	8	54	15	400		94.9	160	62	2.9
		85	23.6	360		117.4		71	4.6
		97	27	320		124.4		68	5.5
	9	54	15	450		106.8	160	62	2.9
		85	23.6	405		132.1		71	4.6
		97	27	360		139.9		68	5.5
	10	54	15	500		118.7	200	62	2.9
		85	23.6	450		146.8		71	4.6
		97	27	400		155.5		68	5.5
	11	54	15	550		130.5	200	62	2.9
		85	23.6	495		161.5		71	4.6
		97	27	440		171.0		68	5.5
	12	54	15	600		142.4	220	62	2.9
		85	23.6	540		176.2		71	4.6
		97	27	480		186.6		68	5.5

125MD25 型矿用耐磨多级离心泵性能曲线表 (n=2950r/min)

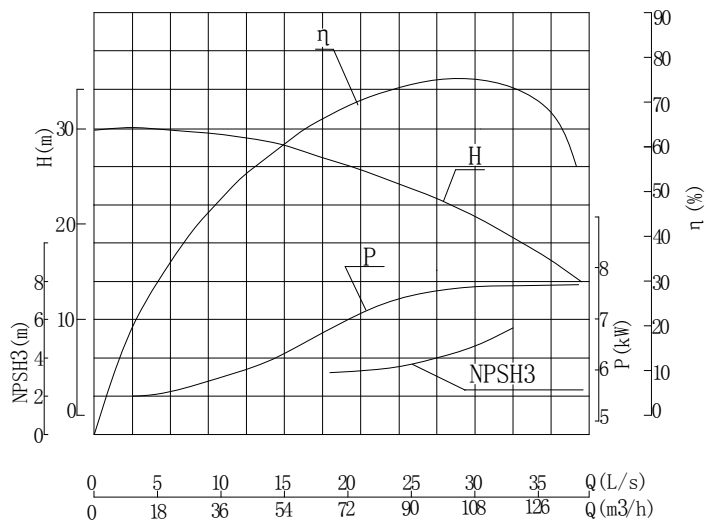

泵的型号	级数	流量 Q		扬程 H (m)	转速 n (r/min)	功率 P (kW)		效率 η (%)	必需汽蚀余量 NPSHR (m)
		(m³/h)	(L/s)			轴功率	电机功率		
125MD25	2	72	20	51.2	2950	14.8	22	68	2.6
		101	28	43		15.9		74.5	4.0
		119	33	35		16.0		71	5.1
	3	72	20	76.8		22.2	30	68	2.6
		101	28	64.5		23.8		74.5	4.0
		119	33	52.5		24.0		71	5.1
	4	72	20	102.4		29.5	37	68	2.6
		101	28	86		31.8		74.5	4.0
		119	33	70		32.0		71	5.1
	5	72	20	128		36.9	45	68	2.6
		101	28	107.5		39.7		74.5	4.0
		119	33	87.5		40.0		71	5.1
	6	72	20	153.5		44.3	55	68	2.6
		101	28	129		47.7		74.5	4.0
		119	33	105		48.0		71	5.1
	7	72	20	179.2		51.7	75	68	2.6
		101	28	150.5		55.6		74.5	4.0
		119	33	122.5		55.9		71	5.1
	8	72	20	204.8		59.1	75	68	2.6
		101	28	172		63.5		74.5	4.0
		119	33	140		63.9		71	5.1
	9	72	20	230.4		66.5	90	68	2.6
		101	28	193.5		71.5		74.5	4.0
		119	33	157.5		71.9		71	5.1

150MD30 型矿用耐磨多级离心泵性能曲线表 (n=1480r/min)

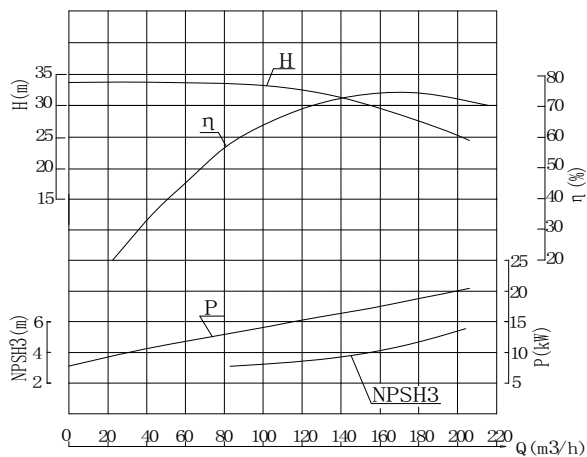

泵的型号	级数	流量 Q		扬程 H (m)	转速 n (r/min)	功率 P (kW)		效率 η (%)	必需汽蚀余量 NPSHR (m)
		(m³/h)	(L/s)			轴功率	电机功率		
150MD30	2	119	33.06	62	1480	27.2	45	74	3.0
		155	43.06	58		31.8		77	3.5
		190	52.78	52.6		36.3		75	5.0
	3	119	33.06	93		40.8	75	74	3.0
		155	43.06	87		47.7		77	3.5
		190	52.78	79		54.5		75	5.0
	4	119	33.06	124		54.3	90	74	3.0
		155	43.06	116		63.6		77	3.5
		190	52.78	106		73.2		75	5.0
	5	119	33.06	156		68.4	110	74	3.0
		155	43.06	145		79.5		77	3.5
		190	52.78	133		91.8		75	5.0
	6	119	33.06	186		81.5	132	74	3.0
		155	43.06	174		95.4		77	3.5
		190	52.78	159		109.8		75	5.0
	7	119	33.06	217		95.1	160	74	3.0
		155	43.06	208		114.1		77	3.5
		190	52.78	186		128.4		75	5.0
	8	119	33.06	248		108.7	160	74	3.0
		155	43.06	232		127.3		77	3.5
		190	52.78	212		146.3		75	5.0
	9	119	33.06	279		122.3	200	74	3.0
		155	43.06	261		143.2		77	3.5
		190	52.78	239		165.0		75	5.0
	10	119	33.06	310		135.8	200	74	3.0
		155	43.06	290		159.1		77	3.5
		190	52.78	265		182.9		75	5.0
	11	119	33.06	341		149.4	220	74	3.0
		155	43.06	319		175.0		77	3.5
		190	52.78	291.5		201.2		75	5.0
	12	119	33.06	372		163.0	250	74	3.0
		155	43.06	348		190.9		77	3.5
		190	52.78	318		219.5		75	5.0



200MD43 型煤矿用耐磨多级离心泵性能曲线表 (n=1480r/min)

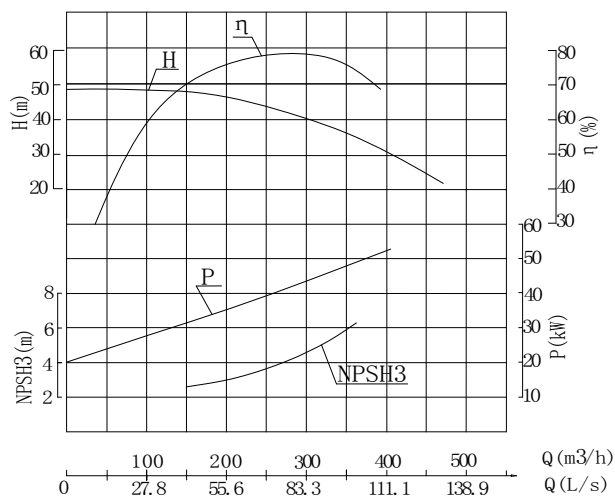

泵的型号	级数	流量 Q		扬程 H (m)	转速 n (r/min)	功率 P (kW)		效率 η (%)	必需汽蚀余量 NPSHR (m)
		(m³/h)	(L/s)			轴功率	电机功率		
200MD43	2	190	52.78	90.6	1480	64.3	110	73	2.5
		288	80.00	81.9		80.3		80	4.3
		346	96.11	74.9		90.5		78	5.5
	3	190	52.78	135.9		96.4	160	73	2.5
		288	80.00	122.4		120.1		80	4.3
		346	96.11	111		134.2		78	5.5
	4	190	52.78	181.2		128.5	200	73	2.5
		288	80.00	163.2		160.1		80	4.3
		346	96.11	148		178.9		78	5.5
	5	190	52.78	226.5		160.6	250	73	2.5
		288	80.00	204		200.1		80	4.3
		346	96.11	185		223.6		78	5.5
	6	190	52.78	271.8		192.8	315	73	2.5
		288	80.00	244.8		240.1		80	4.3
		346	96.11	222		268.3		78	5.5
	7	190	52.78	317.1		224.9	355	73	2.5
		288	80.00	285.5		280.1		80	4.3
		346	96.11	259		313.1		78	5.5
	8	190	52.78	392.4		278.3	400	73	2.5
		288	80.00	326.4		320.2		80	4.3
		346	96.11	296		357.8		78	5.5
	9	190	52.78	407.7		289.1	450	73	2.5
		288	80.00	367.2		360.2		80	4.3
		346	96.11	333		402.5		78	5.5
	10	190	52.78	453		321.3	560	73	2.5
		288	80.00	409.5		401.7		80	4.3
		346	96.11	374.5		452.7		78	5.5
	11	190	52.78	498.3		353.4	630	73	2.5
		288	80.00	449.9		441.3		80	4.3
		346	96.11	412		497.9		78	5.5
	12	190	52.78	543.6		385.5	710	73	2.5
		288	80.00	490.8		481.4		80	4.3
		346	96.11	449.4		543.2		78	5.5

250MD60 型矿用耐磨多级离心泵性能曲线表 (n=1480r/min)

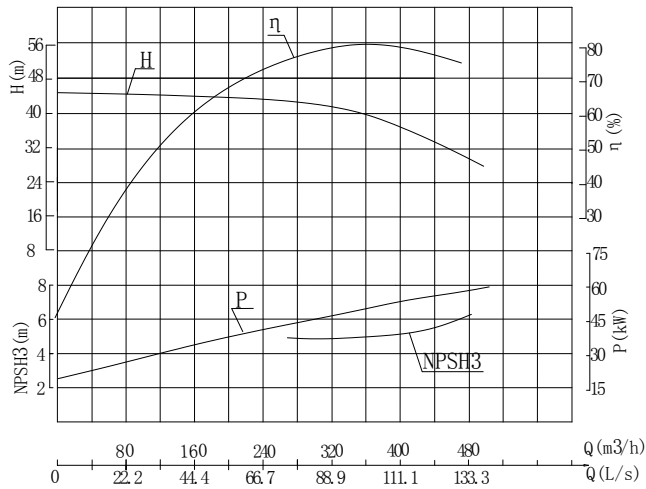

泵的型号	级数	流量 Q		扬程 H (m)	转速 n (r/min)	功率 P (kW)		效率 η (%)	必需汽蚀余量 NPSHR (m)
		(m³/h)	(L/s)			轴功率	电机功率		
250MD60	2	335	93.1	130	1480	164.8	220	72	3.8
		450	125	120		186.3		79	4.9
		500	139	114		199.1		78	6.0
	3	335	93.1	195		247.2	355	72	3.8
		450	125	180		279.4		79	4.9
		500	139	171		298.7		78	6.0
	4	335	93.1	260		329.6	450	72	3.8
		450	125	240		372.5		79	4.9
		500	139	228		398.2		78	6.0
	5	335	93.1	325		412.0	450	72	3.8
		450	125	300		465.6		79	4.9
		500	139	285		497.8		78	6.0
	6	335	93.1	390		494.4	710	72	3.8
		450	125	360		558.8		79	4.9
		500	139	342		597.4		78	6.0
	7	335	93.1	455		576.9	800	72	3.8
		450	125	420		651.9		79	4.9
		500	139	399		696.9		78	6.0
	8	335	93.1	520		659.3	900	72	3.8
		450	125	480		745.0		79	4.9
		500	139	456		796.5		78	6.0
	9	335	93.1	585		741.7	1000	72	3.8
		450	125	540		838.1		79	4.9
		500	139	513		896.1		78	6.0
	10	335	93.1	650		824.1	1120	72	3.8
		450	125	600		931.3		79	4.9
		500	139	570		995.6		78	6.0
	11	335	93.1	715		906.5	1250	72	3.8
		450	125	660		1024.4		79	4.9
		500	139	627		1095.2		78	6.0
	12	335	93.1	780		988.9	1400	72	3.8
		450	125	720		1117.5		79	4.9
		500	139	684		1194.7		78	6.0

11 MD 型矿用耐磨多级离心泵安装图



图3 | MD 型矿用耐磨多级离心泵（整体底座）



图 4 MD 型煤矿用耐磨多级离心泵（单独底座）

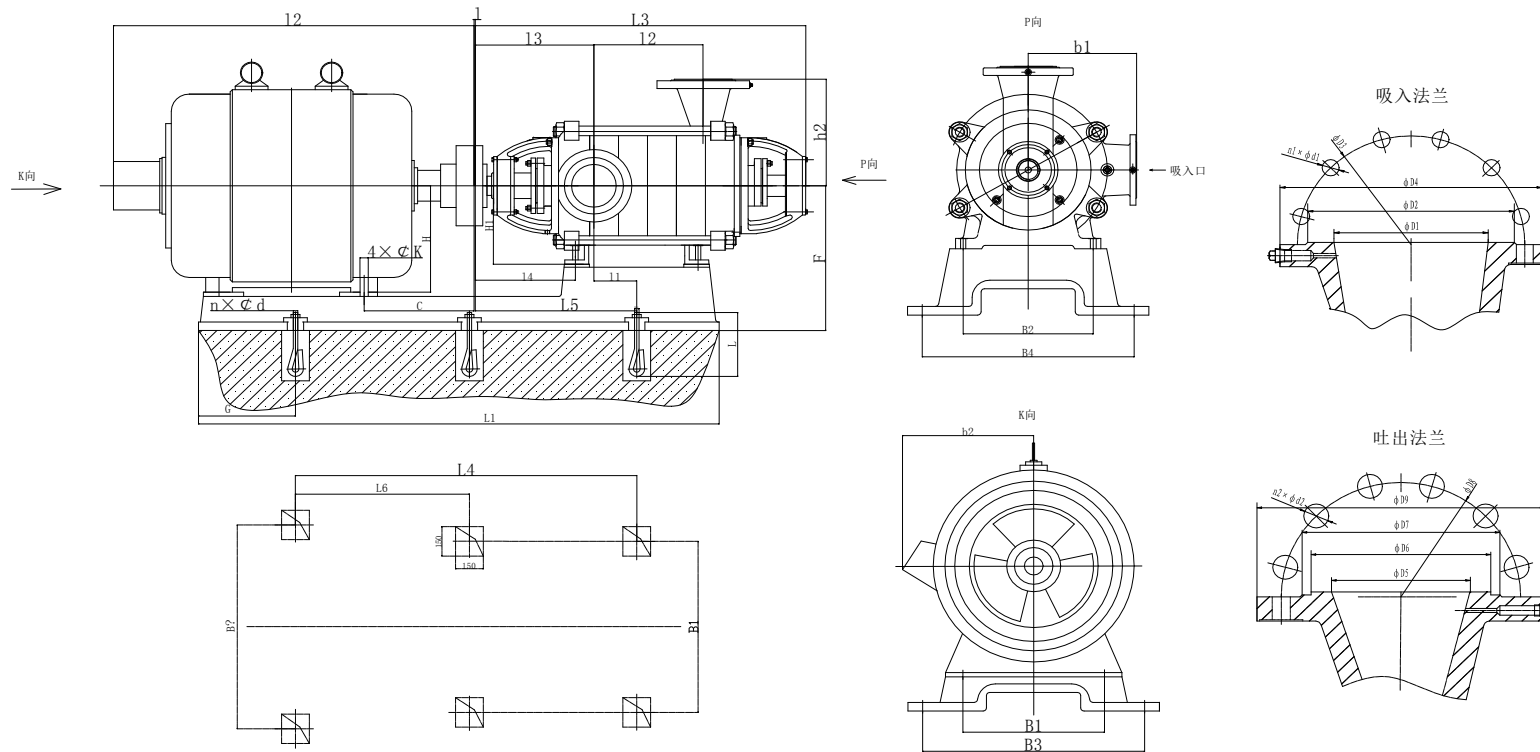

图5 MD型矿用耐磨多级离心泵（独立底座）

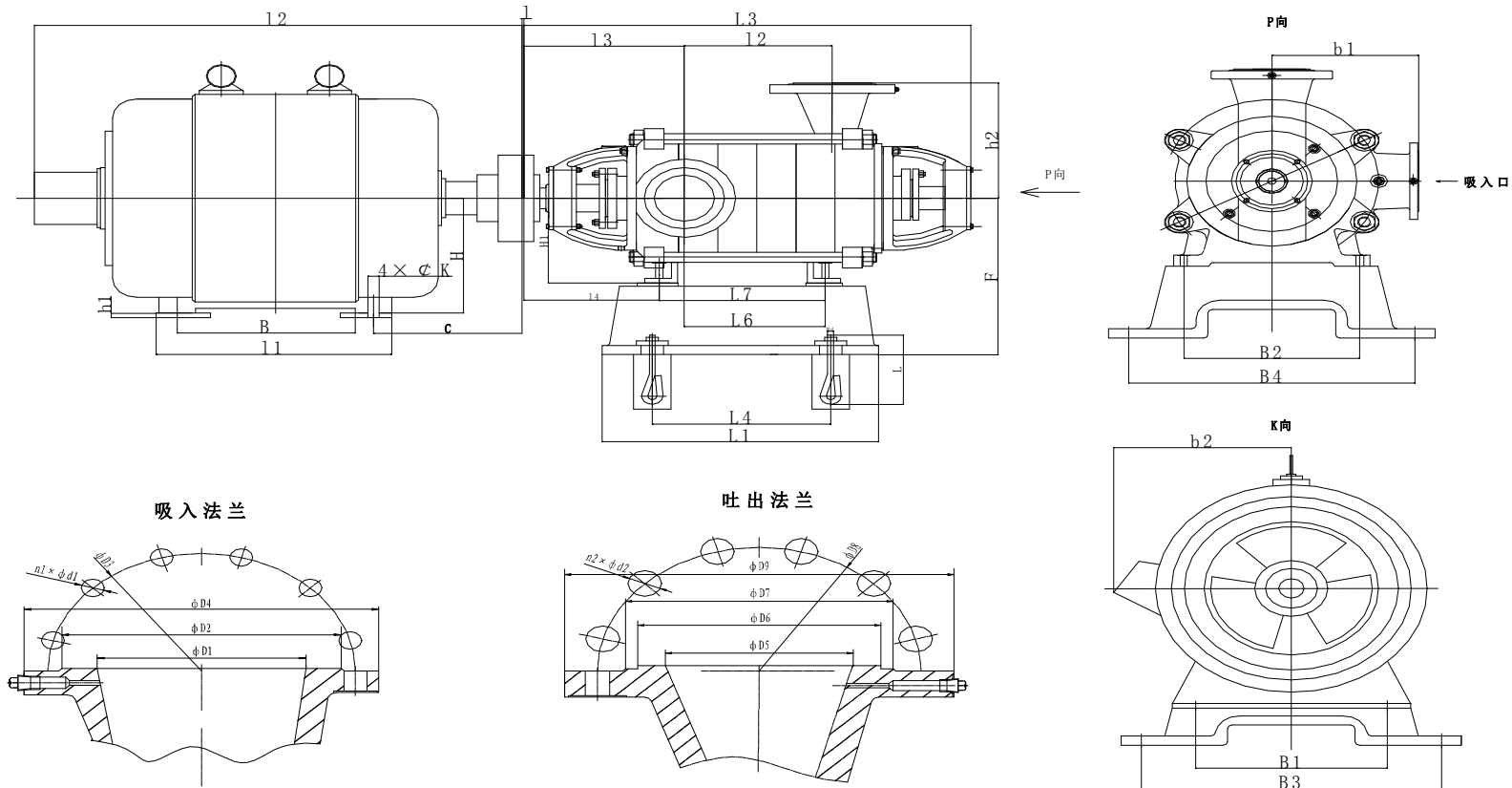

### 12 MD 型矿用耐磨多级离心泵安装尺寸表

泵型号 规格	电机型号	电压 V	功率 kW	机组总 长 L	底座部分								电机部分										泵部分								L <sub>5</sub>	F	e	法兰尺寸												
					L <sub>1</sub>	L <sub>4</sub>	L <sub>6</sub>	B <sub>3</sub>	B <sub>4</sub>	G	n	l <sub>2</sub>	l <sub>1</sub>	B	B <sub>1</sub>	C	H	h	h <sub>1</sub>	k	b <sub>2</sub>	L <sub>3</sub>	L <sub>2</sub>	l <sub>3</sub>	l <sub>4</sub>	H <sub>1</sub>	h <sub>2</sub>	B <sub>2</sub>	b <sub>1</sub>	进口法兰				出口法兰												
MD6-25	×2	YB2-112M-2	380	4	1048	770	450	—	440	440	160	4	400	180	140	360	130	112	188	15	12	190	645	130	265	265	150	170	410	280	240	3	进口法兰	D <sub>1</sub>	∅40	n <sub>1</sub> -d <sub>1</sub>										
	×3	YB2-132S1-2	380	5.5	1170	859	600	—			129		472	190	140	390	171	132	213	18	12	210	695	180					440	360	230			D <sub>2</sub>	∅80	4-∅13.5										
	×4	YB2-132S2-2	380	7.5	1220	959	650	—			154		617	260	210	430	220	160	260	20	15	255	845	330					485	170	495			570	240		出口法兰	D <sub>3</sub>	∅100	4-∅17.5						
	×5	YB2-132S2-2	380		1270			—	195	672	305																											254	995		480	1045	530	646	D <sub>4</sub>	∅130
	×6	YB2-160M1-2	380	11	1445	1176	785	—	220	480	480		195	617	260	210	430	220	160	260	20	15	255	845					330	485	170	495	570	240	出口法兰	D <sub>5</sub>	∅40	n <sub>2</sub> -d <sub>2</sub>								
	×7	YB2-160M1-2	380		1515			—																												220	672	305	254	995	480	1045	530	646	D <sub>6</sub>	∅75
	×8	YB2-160M2-2	380	15	1565	1276	835	—	220	480	480		195	617	260	210	430	220	160	260	20	15	255	845					330	485	170	495	570	240	出口法兰	D <sub>7</sub>	∅88	4-∅17.5								
	×9	YB2-160M2-2	380		1615			—																												220	672		305	254	995	480	1045	530	646	D <sub>8</sub>
	×10	YB2-160L-2	380	18.5	1720	1422	935	—	243	480	480		195	617	260	210	430	220	160	260	20	15	255	845					330	485	170	495	570	240	出口法兰	D <sub>9</sub>	∅150									
	×11	YB2-160L-2	380		1770			—																												243	672	305	254	995	480	1045	530	646	D <sub>9</sub>	∅150
	×12	YB2-160L-2	380		1820			1472																												985	—	243	672	305	254	995	480	1045	530	646
	地脚螺栓 GB799-88 (Md×l): M20×300																																													
MD12-25	×2	YB2-132S1-2	380	5.5	1118	809	500	—	440	440	154	4	470	190	140	390	169	132	213	18	12	210	645	130	265	265	150	170	440	285	230	3	进口法兰	D <sub>1</sub>	∅50	n <sub>1</sub> -d <sub>1</sub>										
	×3	YB2-132S2-2	380	7.5	1170	859	600	—			129		472	190	140	390	171	132	213	18	12	210	695	180					445	360	230			D <sub>2</sub>	∅90	4-∅13.5										
	×4	YB2-160M1-2	380	11	1365	1076	730	—			173		617	260	210	430	220	160	260	20	15	255	845	330					480	170	495			240	出口法兰		D <sub>3</sub>	∅110	4-∅17.5							
	×5	YB2-160M1-2	380	11	1415			—	173	672																											305	254		995	480	1045	430	579	D <sub>4</sub>	∅140
	×6	YB2-160M2-2	380	15	1465	1176	785	—	195	480	480		195	617	260	210	430	220	160	260	20	15	255	845					330	480	170	495	240	出口法兰	D <sub>5</sub>	∅40	n <sub>2</sub> -d <sub>2</sub>									
	×7	YB2-160M2-2	380	15	1515			—																											195	672	305	254	995	480	1045	430	579	D <sub>6</sub>	∅75	4-∅17.5
	×8	YB2-160L-2	380	18.5	1720	1322	900	—	211	500	500		268	702	315	241	450	233	180	275	22	19	305	1145					530	450	626	270	出口法兰	D <sub>7</sub>	∅88	4-∅17.5										
	×9	YB2-160L-2	380	18.5	1770			—																										211	702		315	241	450	233	180	275	22	19	305	
	×10	YB2-180M-2	380	22	1850	1436	900	—	268	500	500		268	702	315	241	450	233	180	275	22	19	305	1145					530	450	626	270	出口法兰	D <sub>9</sub>	∅150											
	×11	YB2-180M-2	380	22	1900			—																										268	702	315	241	450	233	180	275	22	19	305	1145	530
	×12	YB2-200L1-2	380	30	2020	1555	980	—	550	550	587		772	375	305	500	245	200	305	19	305	1245	630	500					657	290	出口法兰															
	地脚螺栓 GB799-88 (Md×l): M20×300																																													
MD12-50	×2	YB2-160M1-2	380	11	1422	1116	800	—	254	520	158	4	615	260	210	254	218	160	260	20	15	255	803	180	313	286	200	230	470	230	290	4	进口法兰	D <sub>1</sub>	∅50	n <sub>1</sub> -d <sub>1</sub>										
	×3	YB2-160M2-2	380	15	1482	1116	800	—			190		700	315	241	279	231	180	275	22			280	923					300	305	1043			420	468	240	495	290	D <sub>2</sub>	∅100	4-∅17.5					
	×4	YB2-180M-2	380	22	1627	1204	850	—			279		770	375	305	318	243	200	305	25			19	305					1103	480	470			230	627	345	出口法兰	D <sub>3</sub>	∅125	4-∅22						
	×5	YB2-200L1-2	380	30	1757			1416	940	—											318	820																400	311			356	259	225	330	28
	×6	YB2-200L1-2	380	30	1817	1638	1300	650	356	169	520		238	615	260	210	254	218	160	260	20	15	255	803					180	470	230	627	345	出口法兰	D <sub>5</sub>	∅50	n <sub>2</sub> -d <sub>2</sub>									
	×7	YB2-200L2-2	380	37	1877																														1476	1000	—	318	820	400	311	356	259	225	330	28
	×8	YB2-225M-2	380	45	1987	1866	1400	700	406	233	520		233	615	260	210	254	218	160	260	20	15	255	803					180	470	230	627	345	出口法兰	D <sub>7</sub>	∅105	4-∅22									
	×9	YB2-225M-2	380	45	2047																														1638	1300		650	356	169	520	238	615	260	210	254
	×10	YB2-250M-2	380	55	2202	1866	1400	700	406	233	520		233	615	260	210	254	218	160	260	20	15	255	803					180	470	230	627	345	出口法兰	D <sub>9</sub>	∅175										
	×11	YB2-250M-2	380	55	2262																														1866	1400	700	406	233	520	233	615	260	210	254	218
	×12	YB2-280S-2	380	75	2382	1996	—	457	298	975	490		368	457	330	280	400	35	24	400	1403	780	893	400					出口法兰																	
	地脚螺栓 GB799-88 (Md×l): M20×300																																													

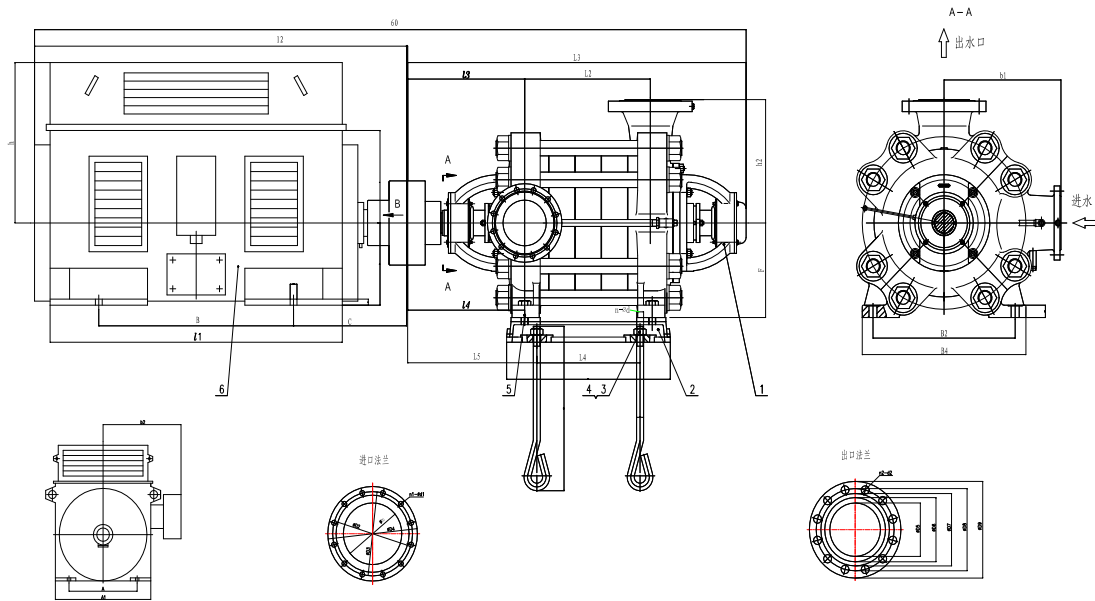

泵型号 规格	电机型号	电压 V	功率 kW	机组总 长 L	底座部分								电机部分										泵部分								L <sub>5</sub>	F	e	法兰尺寸															
					L <sub>1</sub>	L <sub>4</sub>	L <sub>6</sub>	B <sub>3</sub>	B <sub>4</sub>	G	n	l <sub>2</sub>	l <sub>1</sub>	B	B <sub>1</sub>	C	H	h	h <sub>1</sub>	k	b <sub>2</sub>	L <sub>3</sub>	L <sub>2</sub>	l <sub>3</sub>	l <sub>4</sub>	H <sub>1</sub>	h <sub>2</sub>	B <sub>2</sub>	b <sub>1</sub>	进口法兰				出口法兰															
MD25-30	×2	YB2-160M1-2	380	11	1398	1098	745	—	520	520	177	4	615	260	210	460	220	160	250	20	15	255	780	165	330	315	170	210	460	210	434	250	3	进口法兰	D <sub>1</sub>	Φ 65	n <sub>1</sub> -d <sub>1</sub>												
	×3	YB2-160M2-2	380	15	1463	1098	745	—					177	615	210			160	250		15	255	845	230							434	250			D <sub>2</sub>	Φ 110	4-Φ 17.5												
	×4	YB2-160L-2	380	18.5	1583	1207	850	—					178	670	305			254	233		180	275	22	15							280	975			360	496		260	D <sub>3</sub>	Φ 130									
	×5	YB2-180M-2	380	22	1678	1293	880	—	201	700	315	241	229	250	30	24	365	1365	750	539	260	D <sub>4</sub>	Φ 160																										
	×6	YB2-200L1-2	380	30	1813	1483	1000	—	565	520	241	4	770	375	305	505	220	200	305	25	19	305	1040	425	330	315	170	210	460	210	631	290	3	出口法兰	D <sub>5</sub>	Φ 65	n <sub>2</sub> -d <sub>2</sub>												
	×7	YB2-200L1-2	380	30	1878	1483	1000	—															266	770							375	305			505	220	200	305	25	19	305	1105	490	736	315	D <sub>6</sub>	Φ 109	8-Φ 17.5	
	×8	YB2-200L2-2	380	37	1943	1613	1080	—															292	820							400	311			640	261	225	330	28	19	335	1300	685	778	315	D <sub>7</sub>	Φ 122		
	×9	YB2-200L2-2	380	37	2008	1613	1080	—	229	915	445	349	660	308	250	365	30	24	365	1365	750	982	370	D <sub>8</sub>	Φ 145																								
	×10	YB2-225M-2	380	45	2123	1705	1120	—	700	915	445	349	660	308	250	365	30	24	365	1365	750	982	370																										
	×11	YB2-250M-2	380	55	2283	1958	1500	—	600	915	445	349	660	308	250	365	30	24	365	1365	750	982	370																										
	×12	YB2-250M-2	380	55	2348	1958	1500	—	600	915	445	349	660	308	250	365	30	24	365	1365	750	982	370																										
	地脚螺栓 GB799-88 (Md×l): M16×300 (2~5) M20×300 (6~12)																																																
MD25-50	×2	YB2-160L-2	380	18.5	1526	1153	800	—	530	177	4	185	324	245	470	218	180	225	22	15	255	877	185	330	320.5	210	270	470	300	440	300	4	进口法兰	D <sub>1</sub>	Φ 65	n <sub>1</sub> -d <sub>1</sub>													
	×3	YB2-200L1-2	380	30	1718	1346	900					—	530	223		4	245	379	305	470	243	200	275							27	19			310	937	245	330	320.5	210	270	470	300	513	290	4	出口法兰	D <sub>2</sub>	Φ 120	4-Φ 18
	×4	YB2-200L2-2	380	37	1778												1460	1000	545		230	305	311							505	259			225	305	28							19	345			1057	365	
	×5	YB2-225M-2	380	45	1876	1460	1000	545	188	425	465	349	600	308	250	325	33	24	410	1117	425	740	370	D <sub>4</sub>	Φ 185																								
	×6	YB2-250M-2	380	55	2051	1675	1300	650	650	188	6	485	465	349	600	308	250	325	33	24	410	1177	485	330	320.5	210	270	470	300	868	400	4	出口法兰	D <sub>5</sub>	Φ 65	n <sub>2</sub> -d <sub>2</sub>													
	×7	YB2-250M-2	380	55	2111																	1865	1500							750	710			183	545	536	368	650	331	280	360	38	24	410	1237	545	950	400	D <sub>6</sub>
	×8	YB2-280S-2	380	75	2243	2043	1600	800	710	222	605	600	419	650	331	280	360	38	24	410	1297	605	1017							435	D <sub>7</sub>			Φ 130															
	×9	YB2-280S-2	380	75	2303	2043	1600	800	710	222	665	600	419	650	331	280	360	38	24	410	1357	665	1017	435	D <sub>8</sub>	Φ 160																							
	×10	YB2-280M-2	380	90	2413	2043	1600	800	810	218	6	785	619	406	750	358	315	455	50	28	530	1477	785	330	320.5	210	270	470	300	950	400	4	出口法兰	D <sub>9</sub>	Φ 205														
	×11	YB2-280M-2	380	90	2473																	2043	1600							800	810			218	785	619	406	750	358	315	455	50	28	530	1477	785	1017	435	
	×12	YB2-315S-2	380	110	2653	2135	1700	850	810	218	785	619	406	750	358	315	455	50	28	530	1477	785	1017							435																			
	地脚螺栓 GB799-88 (Md×l): M20×300																																																
MD46-30	×2	YB2-160L-2	380	18.5	1453	1062	800	—	460	131	4	670	305	254	520	218	160	260	20	15	255	780	165	330	315	170	210	450	210	399	250	3	进口法兰	D <sub>1</sub>	Φ 80	n <sub>1</sub> -d <sub>1</sub>													
	×3	YB2-180M-2	380	22	1520	1162	800					700	530	180	4	672	332	241	450	233	180	250	24							15	285			845	230	330	315	170	210	450	210	468	270	3	出口法兰	D <sub>2</sub>	Φ 128	4-Φ 17.5	
	×4	YB2-200L1-2	380	30	1690	1302	900									530	194	777	379	305	470	245	200							275	27			19	310							910	295			484	290		D <sub>3</sub>
	×5	YB2-200L2-2	380	37	1755	1367	1000	530	209	777	379	305	470	245	200	275	27	19	310	975	360	599	290	D <sub>4</sub>	Φ 190																								
	×6	YB2-200L2-2	380	37	1820	1432	1000	530	209	817	407	311	505	261	225	305	28	24	400	1040	425	599	290																										
	×7	YB2-225M-2	380	45	1925	1533	1100	565	510	205	817	407	311	505	261	225	305	28	24	400	1105	490	671	315																									
	×8	YB2-250M-2	380	55	2105	1694	1400	660	510	182	932	458	349	600	310	250	325	33	24	385	1170	555	834	370																									
	×9	YB2-250M-2	380	55	2170	1759	1400	660	510	182	932	458	349	600	310	250	325	33	24	385	1235	620	834	370																									
	×10	YB2-280S-2	380	75	2305	1897	1500	750	710	199	1002	536	368	650	332	280	360	28	24	410	1300	685	679	400																									
	×11	YB2-280S-2	380	75	2343	1968	1600	800	650	181	975	490	710	330	280	400	35	24	400	1365	750	967	400																										
	×12	YB2-280M-2	380	90	2458	2028	1600	800	650	214	1025	540	710	330	280	400	35	24	400	1430	815	1000	400																										
	地脚螺栓 GB799-88 (Md×l): M20×300																																																



泵型号 规格	电机型号	电压 V	功率 kW	机组总 长 L	底座部分							电机部分										泵部分							L <sub>5</sub>	F	e	法兰尺寸																					
					L <sub>1</sub>	L <sub>4</sub>	L <sub>6</sub>	B <sub>3</sub>	B <sub>4</sub>	G	n	l <sub>2</sub>	l <sub>1</sub>	B	B <sub>1</sub>	C	H	h	h <sub>1</sub>	k	b <sub>2</sub>	L <sub>3</sub>	L <sub>2</sub>	l <sub>3</sub>	l <sub>4</sub>	H <sub>1</sub>	h <sub>2</sub>	B <sub>2</sub>				b <sub>1</sub>	进口法兰	D <sub>1</sub>	Φ	n <sub>1</sub> -d <sub>1</sub>																	
MD46-50	×2	YB2-200L1-2	380	30	1658	1286	900	—	530	530	183	4	777	379	305	530	243	200	275	27	19	310	877	185	353	320.5	210	30	300	483	290	4	进口法兰	D <sub>1</sub>	Φ 80	n <sub>1</sub> -d <sub>1</sub>																	
	×3	YB2-200L2-2	380	37	1718																													565	238	815	390	311	565	259	225	305	28	20	345	997	305	937	245	315	D <sub>2</sub>	Φ 128	4-Φ 18
	×4	YB2-225M-2	380	45	1816																													660	278	830	465	349	660	309	250	325	33	—	385	1057	365	501	370	D <sub>3</sub>	Φ 150		
	×5	YB2-250M-2	380	55	1991	710	223	1002	536		365	710	331	280	360	38	24	410	1117	425	530	400	D <sub>4</sub>	Φ 190				8-Φ 23																									
	×6	YB2-280S-2	380	75	2123	810	231	1052	600		419	—	—	—	—	—	—	—	—	—	708	400	D <sub>5</sub>	Φ 80						n <sub>2</sub> -d <sub>2</sub>																							
	×7	YB2-280S-2	380	75	2183	258	258	1172	619		406	810	358	315	455	50	28	530	1237	545	759	435	D <sub>6</sub>	Φ 120						8-Φ 23																							
	×8	YB2-280M-2	380	90	2293	810	258	1052	600		419	—	—	—	—	—	—	—	—	—	759	435	D <sub>7</sub>	Φ 133				8-Φ 23																									
	×9	YB2-315S-2	380	110	2473	2166	1700	850	243		1220	670	457	—	—	—	—	—	—	—	856	435	D <sub>8</sub>	Φ 170							8-Φ 23																						
	×10	YB2-315S-2	380	110	2533	2166	1700	850	243		1220	670	457	—	—	—	—	—	—	—	991	435	D <sub>9</sub>	Φ 215						8-Φ 23																							
	×11	YB2-315M-2	380	132	2641	2166	1700	850	243		1220	670	457	—	—	—	—	—	—	—	991	435	—	—				8-Φ 23																									
	×12	YB2-315M-2	380	132	2701	2166	1700	850	243		1220	670	457	—	—	—	—	—	—	—	991	435	—	—							8-Φ 23																						
	地脚螺栓 GB799-88 (Md×l): M20×300																																																				
MD85-45	×2	YB2-200L2-2	380	37	1610	1205	800	—	570	570	203	4	770	379	305	580	243	200	305	25	19	305	836	203	326	307	210	—	250	394		290	4	进口法兰	D <sub>1</sub>	Φ 100	n <sub>1</sub> -d <sub>1</sub>																
	×3	YB2-250M-2	380	55	1829	1428	800																								650				264	915	465	349	675	306	250	365	30	—	345	910	277	418	370	D <sub>2</sub>	Φ 148	4-Φ 17.5	
	×4	YB2-280S-2	380	75	1963	1572	1100																								710				236	975	536	368	730	330	280	400	35	24	400	984	351	523	400	D <sub>3</sub>	Φ 170		8-Φ 22
	×5	YB2-280M-2	380	90	2087	1704		302	1025		600	419	—	—	—	—	—	—	—	—	—	1058	425	531				400		D <sub>4</sub>		Φ 210																					
	×6	YB2-315S-2	380	110	2351	1885	1400	700	810		242	1215	620	406	810	356	315	530	45	28	525	1132	499	742				435		D <sub>5</sub>	Φ 100	n <sub>2</sub> -d <sub>2</sub>																					
	×7	YB2-315M-2	380	132	2535	1935					268	1325	670	457										—						—	—	—		—	—	—	—	—	1206	573	717	435	D <sub>6</sub>	Φ 158	8-Φ 22								
	×8	YB2-315M-2	380	132	2609	1935	1800	750	810		272	1325	740	508	810	356	315	530	45	28	525	1280	647	860				435		D <sub>7</sub>	Φ 190	8-Φ 22																					
	×9	YB2-315L1-2	380	160	2683	2144					1600	800	245											1325						680	—			—	—	—	—	—	—	—	1354	721	1034	475		D <sub>8</sub>	Φ 235						
	×10	YB2-315L2-2	380	200	2757	2292	1800	750	810		245	1325	680	—	—	—	—	—	—	—	—	1428	795	1034				475		—	—																						
	×11	YB2-315L2-2	380	200	2831	2292					1800	750	810	270	1495	760	560	910	394	355	655	52	—	—						1502	869	1034		475	—	—																	
	×12	YB2-355M1-2	380	220	3075	2441	1900	850	270					1495	760	560	910	394	355	655	52	—	—	655				1576		943	475	—			—																		
	地脚螺栓 GB799-88 (Md×l): M20×300																																																				
MD85-67	×2	YB2-280S-2	380	75	2298	1605	1200	600	650	670	202	6	975	490	368	610	330	280	400	35	24	400	1318	283	565	557	270	—	350	715	400	5	进口法兰	D <sub>1</sub>	Φ 100	n <sub>1</sub> -d <sub>1</sub>																	
	×3	YB2-280M-2	380	90	2436	1877	1200	600	650																									338	1025	610	720	720	331	280	360	36	—	410	1408	371	557	400	D <sub>2</sub>	Φ 148	4-Φ 17.5		
	×4	YB2-315S-2	380	110	2714	1999	1400	700	750																									300	1215	630	—	—	—	—	—	—	—	—	1484	459	799	435	D <sub>3</sub>	Φ 170		8-Φ 26	
	×5	YB2-315M-2	380	132	2912	2137	1500	750	750		319	1325	680	820	820	358	315	445	50	28	530	1582	547	868				435		D <sub>4</sub>	Φ 210																						
	×6	YB2-315L1-2	380	160	3000	2374	1700	850	750		337	1325	750											—						—	—		—	—	—	—	1670	635	1025	390	D <sub>5</sub>	Φ 100	n <sub>2</sub> -d <sub>2</sub>										
	×7	YB2-315L2-2	380	200	3088	2374	1700	850	750		—	—	—	—	—	—	—	—	—	—	—	1758	723	1025				390		D <sub>6</sub>	Φ 149		8-Φ 26																				
	×8	YB2-355M1-2	380	220	3346	1054	760	730	730		—	1495	754	560	610	355	655	52	28	655	1741	811	501	390						D <sub>7</sub>	Φ 168																						
	×9	YB2-355M2-2	380	250	3434	1230	848	730	730		—	1495	760	630									394					355		655	52			—	—	680	2022	987	627	390	D <sub>8</sub>	Φ 200											
	×10	YB2-355L1-2	380	280	3567	1230	848	730	730		—	1495	760	630	394	355	655	52	—	—	680	2022	987	627				390		D <sub>9</sub>	Φ 250																						
	×11	YB2-355L2-2	380	315	3610	1230	848	730	730		—	1495	760	630	394	355	655	52	—	—	680	2022	987	627						390	—		—																				
	×12	YB2-400S-2	380	355	4073	1318	936	760	760		—	1870	—	800	630	—	—	—	—	—	775	—	35	760				2198			1163		627	—	—																		
	地脚螺栓 GB799-88 (Md×l): M24×400																																																				





泵型号 规格	电机型号	电压 V	功率 kW	机组总 长 L	底座部分							电机部分										泵部分							L <sub>5</sub>	F	e	法兰尺寸																																																																																								
					L <sub>1</sub>	L <sub>4</sub>	L <sub>6</sub>	B <sub>3</sub>	B <sub>4</sub>	G	n	l <sub>2</sub>	l <sub>1</sub>	B	B <sub>1</sub>	C	H	h	h <sub>1</sub>	k	b <sub>2</sub>	L <sub>3</sub>	L <sub>2</sub>	l <sub>3</sub>	l <sub>4</sub>	H <sub>1</sub>	h <sub>2</sub>	B <sub>2</sub>				b <sub>1</sub>	进口法兰	D <sub>1</sub>	Φ	n <sub>1</sub> -d <sub>1</sub>																																																																																				
MD85-80	×2	YB2-280M-2	380	90	2182	1634	—	720	670	—	6	1025	540	419	650	320	280	400	35	24	400	1152	230	454	434	270	350	600	350	545	270	5	进口法兰	D <sub>1</sub>	Φ 100	n <sub>1</sub> -d <sub>1</sub>																																																																																				
	×3	YB2-315S-2	380	110	2452	1748	—	—				—	—	—	1215	570	406	—	—	—	—	—	—							—				—	—	—	—	—	—	—	—	—	—	—	—	D <sub>2</sub>	Φ 155	8-Φ 18																																																																								
	×4	YB2-315L1-2	380	160	2642	2019	1500	—				820	—	—	1325	680	508	750	356	315	530	45	—							525				1312	390	655	655	270	350	600	350	505	270	5	出口法兰	D <sub>3</sub>	Φ 180		8-Φ 30																																																																							
	×5	YB2-315L2-2	380	200	2722										—																			—	—											—	—			—	1325	—	—	—	—	—	—	—	—	—	1392	470	655	655	270	350	600	350	505	270	5	出口法兰	D <sub>4</sub>	Φ 215																																														
	×6	YB2-355M1-2	380	220	2972	1634	—	730				670	—	—	4	1495	760	560	610	394	355	655	52							28			655	1472	550	454	434	270	350	600	350	505	270	5	出口法兰	D <sub>5</sub>	Φ 100	n <sub>2</sub> -d <sub>2</sub>																																																																								
	×7	YB2-355M2-2	380	250	3052	1748	585											—	—															—	—											—	—	—	630	506	394	355	655	52	28	655	1552	630	454	434	270	350	600	350	505	270	5	出口法兰	D <sub>6</sub>	Φ 149	8-Φ 30																																																	
	×8	YB2-355L1-2	380	280	3132	2019	—		—	—	—							—	—															—	—											610	610	394	355	655							52	28											655	1632		710	454	434	270	350	600	350	505	270	5	出口法兰	D <sub>7</sub>	Φ 172																																				
	×9	YB2-355L2-2	380	315	3212	2019	—	—	—	—	—	—	—	—	—	—	394	355	655	52	28	655	1712							790			454	434	270	350	600	350	505	270	5	出口法兰	D <sub>8</sub>	Φ 210																																																																												
	×10	YB2-400S-2	380	355	3567	1634	745	—	760	670	—	—	1870	1140	800	630							—							—													—	—	—	760	1782	870	454	434	270	350	600	350	505	270	5	出口法兰	D <sub>9</sub>	Φ 265																																																												
	×11	YB2-400M-2	380	400	3747	1748	905	—									—	—	—	—	—	—											—	—	—	—	—	—	—	760	1872	950					454	434											270	350	600	350	505	270	5	出口法兰	D <sub>10</sub>	Φ 265																																																				
	×12	YB2-4004-2	6000	450	3827	2019	—	—	—	—	—	—	—	—	—	—	—	—	—	—	—	760	1952							1030			454	434	270	350	600	350	505	270	5	出口法兰	D <sub>11</sub>	Φ 265																																																																												
	地脚螺栓 GB799-88 (Md×l): M24×400																																																																																																																							
MD155-30	×2	YB2-225M-4	380	45	1983	1444	1000	—	720	720	—	222	845	390	311	640	289	225	225	27	19	345	1134	310	430	455	280	350	640	350	567	400	4	进口法兰	D <sub>1</sub>	Φ 150	n <sub>1</sub> -d <sub>1</sub>																																																																																			
	×3	YB2-280S-4	380	75	2253	1677	1200	600	780			249	1000	540	308	700	330	280	280	38	24	410	1249	425							430				455	280	350	640	350	655	435	4	进口法兰	D <sub>2</sub>	Φ 211	8-Φ 22																																																																										
	×4	YB2-280M-4	380	90	2418	1898	1300	650	850			284	1050	600	419	700	330	280	280	38	24	410	1364	540																430				455	280		350	640	350	734	435	4	进口法兰	D <sub>3</sub>	Φ 240																																																																	
	×5	YB2-315S-4	380	110	2719	2080	1500	750	850			291	1235	670	457	780	386	315	315	45	—	—	—	550																										1479				655	430	455	280	350	640	350	837	435	4	进口法兰	D <sub>4</sub>	Φ 285																																																						
	×6	YB2-315M-4	380	132	2883	2222	1700	850	720			261	1285	670	457	780	386	315	315	45	—	—	—	550										1594												770				430				455							280				350	640	350	981	435	4	出口法兰	D <sub>5</sub>	Φ 150	n <sub>2</sub> -d <sub>2</sub>																																														
	×7	YB2-315L1-4	380	160	3053	2513	1900	950	720			306	1340	740	508	780	386	315	315	45	—	—	—	576										1709									885			430																						455				280	350	640	350	1425	435	4	出口法兰	D <sub>6</sub>	Φ 211	8-Φ 26																																						
	×8	YB2-315L1-4	380	160	3118	2513	1900	950	720			321																						1340									740										508																							780				386	315		315	45	—	—	—	576	1774	1000	430	455	280	350	640	350	1425	435	4	出口法兰	D <sub>7</sub>	Φ 250																		
	×9	YB2-315L2-4	380	200	3233	2743	2100	1050	720			321	1340	740	508	780	386	315	315	45	—	—	—	576																																								1889																									1115	430							455				280	350	640	350	1526	435	4	出口法兰	D <sub>8</sub>	Φ 300										
	×10	YB2-315L2-4	380	200	3348	2743	2100	1050	720			—																						1570									754										560											610							424					355				680	53	—	—	—	680	2004	1230	430	455																280				350	640	350	1526	435	4	出口法兰	D <sub>9</sub>	Φ 300			
	×11	YB2-355M1-4	380	220	3693	1540	455	—	740			—	1570	754	560	610	424	355	680	53	—	—	—	680																																																							2119							1345	430																									455				280	350	640	350	1110
	×12	YB2-355M2-4	380	250	3763	1540	455	—	730			—																						1525									760										560											610							424					355			655	52	—	—	—	655	2234	1460														430																				455
	地脚螺栓 GB799-88 (Md×l): M24×400																																																																																																																							
MD155-67	×2	YB2-315S-2	380	110	2353	1697	600	—	670	—	4	1215	570	406	508	356	315	530	45	—	—	—	1133	283	565	565	270	350	600	350		547	390	5									进口法兰										D <sub>1</sub>											Φ 150							n <sub>1</sub> -d <sub>1</sub>																																																	
	×3	YB2-315M-2	380	132	2551	702	400	—				630	—	—									1325	680							457	508			356	315	530	45	—		—	—											1221											371							565					565			270	350	600	350	513	390	5	进口法兰																						D <sub>2</sub>							Φ 203					
	×4	YB2-315L2-2	380	200	2639										702	400	—	740	—	—	1325	680																		457				508	356		315	530	45		—	—	—											1309																			459																									565							565					
	×5	YB2-355M1-2	380	220	2942	702	400	—				740	—	—									1540	754							560	610			394	355	680	53	—		—	—													1397	547	565	565	270	350		600	350	509																			390																																					
	×6	YB2-355L1-2	380	280	3030										702	400	—	740	—	—	1540	754																		560			610	394	355		680	53	—	—	—	1485	635	565	565	270					350			600	350	511	390		5	进口法兰																																																		
	×7	YB2-355L2-2	380	315	3073	702	400	—				730	—	—									1495	760							630	—			—	355	655	52	—		—	—				1573						723	565													565		270				350	600	350	511		390	5								进口法兰																																		
	×8	YB2-400S-2	380	355	3465										702	400	—	800	—	—	1750	1360																		900			630	485	—	705	35	—	—	—	1661	811																							565																565	270	350	600	350	509		390	5																					
	×9	YB2-4004-2	6000	450	3634	702	400	—				900	—	—									1750	1360							900	630			485	—	705	3																																																																																		







泵型号 规格	电机型号	电压 V	功率 kW	机组总 长 L	底座部分								电机部分										泵部分								L <sub>5</sub>	F	e	法兰尺寸																		
					L <sub>1</sub>	L <sub>4</sub>	L <sub>6</sub>	B <sub>3</sub>	B <sub>4</sub>	G	n	l <sub>2</sub>	l <sub>1</sub>	B	B <sub>1</sub>	C	H	h	h <sub>1</sub>	k	b <sub>2</sub>	L <sub>3</sub>	L <sub>2</sub>	l <sub>3</sub>	l <sub>4</sub>	H <sub>1</sub>	h <sub>2</sub>	B <sub>2</sub>	b <sub>1</sub>	进口法兰				D <sub>1</sub>	Φ	n <sub>1</sub> -d <sub>1</sub>																
MD600-65	×2	YB2-355L2-4	380	315	3472	871	471	—	800	1030	—	4	1790	1380	900	630	525	355	705	35	28	550	—	531	606	631	430	550	950	600	—	550	6	进口法兰	D <sub>1</sub>	Φ 300	n <sub>1</sub> -d <sub>1</sub>															
	×3	YB2-4501-4	6000	500	3782	871	471	—	900		—		1920	1500	1000	710	545	400	780	40	—		716	—							—				—	—	—	—	—	—	—	—	—	—	—	—	—	—	—	—		
	×4	YB2-4503-4	6000	630	4052	1241	841	—	980		—		2000	1620	1120	800	565	450	870	50	35		—	901							—				—	—	—	—	—	—	—	—	—	—	—	—	—	—	—	—	—	
	×5	YB2-5001-4	6000	800	4437			—			—		—	—									—	—							—				—	—	—	—	—	—	—	—	—	—	—	—	—	—	—	—	—	—
	×6	YB2-5003-4	6000	1000	4622	1611	1211	—	1120		—		2200	1730	1250	900	725	500	1010	50	42		—	1271							—			—	—	—	—	—	—	—	—	—	—	—	—	—	—	—	—	—	—	
	×7	YB2-5004-4	6000	1120	4807			—			—												—	—							—			—	—	—	—	—	—	—	—	—	—	—	—	—	—	—	—	—	—	—
	×8	YB2-5601-4	6000	1250	4992	1981	1581	—	1220		—		2400	1860	1400	900	750	560	1200	50	42		—	1458							—			—	—	—	—	—	—	—	—	—	—	—	—	—	—	—	—	—	—	
	×9	YB2-5602-4	6000	1400	5177			—			—												—	—							—			—	—	—	—	—	—	—	—	—	—	—	—	—	—	—	—	—	—	—
	×10	YB2-5603-4	6000	1600	5562	2351	2051	—	—		—		—	—	—	—	—	—	—	—	—		—	—							—			—	—	—	—	—	—	—	—	—	—	—	—	—	—	—	—	—		
	×11	YB-8001-4	10000	1800	5747	2351	2051	—	—		—		—	—	—	—	—	—	—	—	—		—	—							—			—	—	—	—	—	—	—	—	—	—	—	—	—	—	—	—	—		
	×12	YB-8002-4	10000	2000	5932	2536	2051	—	—		—		—	—	—	—	—	—	—	—	—		—	—							—			—	—	—	—	—	—	—	—	—	—	—	—	—	—	—	—	—		
	地脚螺栓 GB799-88 (Md×l): M36×800																																																			
MD220-40	×2	YB2-315S-4	380	110	2173	1685	1300	650	550	870	—	4	1025	540	419	457	330	280	400	35	24	400	1143	369	391	447	330	400	750	450	612	450	5	进口法兰	D <sub>1</sub>	Φ 200	n <sub>1</sub> -d <sub>1</sub>															
	×3	YB2-315M-4	380	132	2603	1925	1500	750	630		—		1325	680	457	508	386	315	530	45	28	525	1273	499							—				—	—	—	—	—	—	—	—	—	—	—	—	—	—	—	—		
	×4	YB2-315L1-4	380	160	2733	2245	1700	850			900				—								508	610							424				355	655	52	705	50	35	800	1403	629	1533	759	—	—	—	—	—	—	—
	×5	YB2-315L2-4	380	200	2863				—				—	—	—	—	—	—	—	—	—	—	—																			—	—	—	—	—	—	—	—	—	—	—
	×6	YB2-355M2-4	380	250	3192	940	600	—	730		—		1525	760	560	610	424	355	655	52	705	50	35	800							655		1663	889	421	477	330	400	750	450	510	450	4	出口法兰	D <sub>5</sub>	Φ 200	n <sub>2</sub> -d <sub>2</sub>					
	×7	YB2-355L2-4	380	315	3617			—			—																				—		—	—							—				—	—	—	—	—	—	—	—
	×8	YB2-400S-4	380	355	3870	1200	600	—	900		—		1790	1360	900	630	525	355	705	50	35	800	1953	1149							2083		1279	421	477	330	400	750	450	770	450	4			出口法兰	D <sub>6</sub>	Φ 282	12-Φ 30				
	×9	YB2-400M-4	380	400	4000			—			—												—	—							—		—							—						—	—		—	—	—	—
	×10	YB2-400M-4	380	400	4130	1460	600	—	900		—		1920	1500	1000	710	545	400	780	50	35	800	2213	1409							2343		1539	421	477	330	400	750	450	1030	450		4	出口法兰		D <sub>7</sub>	Φ 320		12-Φ 30			
	×11	YB2-400L-4	380	450	4260			—			—												—	—							—		—							—						—	—			—	—	—
	×12	YB2-4501-4	6000	500	4390	1720	—	—	—		—		—	—	—	—	—	—	—	—	—	—	—	—							—		—	—	—	—	—	—	—	—	—	—			—	—	—	—		—	—	—
	地脚螺栓 GB799-88 (Md×l):M24×400																																																			
MD500-57	×2	YB2-355M2-4	380	250	3341	550	235	—	800	940	—	4	1790	1360	900	630	525	355	705	35	28	755	1545	421	588	626	550	840	500	—	530	6	进口法兰	D <sub>1</sub>	Φ 250	n <sub>1</sub> -d <sub>1</sub>																
	×3	YB2-400S-4	380	355	3624	703	388	—	900		—		1920	1500	1000	710	545	400	780	40	800	35	840	1698						574				—	—	—	—	—	—	—	—	—	—	—	—	—	—	—	—	—		
	×4	YB2-4501-4	6000	500	3777	856	541	—			—													—						—				—	—	—	—	—	—	—	—	—	—	—	—	—	—	—	—	—	—	—
	×5	YB2-4503-4	6000	630	4010	1009	694	—	960		—		2000	1620	1120	800	565	450	870	50	42	910	2004	880						—				—	—	—	—	—	—	—	—	—	—	—	—	—	—	—	—	—	—	
	×6	YB2-4504-4	6000	710	4163	1162	847	—			—												—	—						—		—	—	—	—	—	—	—	—	—	—	—	—	—	—	—	—	—	—	—	—	—
	×7	YB2-5002-4	6000	900	4316	1315	1000	—	1120		—		2200	1730	1250	900	725	500	1010	50	42	910	2157	1033						2310		1186	588	626	550	840	500	—	530	6	出口法兰	D <sub>5</sub>	Φ 250	12-Φ 72								
	×8	YB2-5003-4	6000	1000	4669	1468	1153	—			—												—	—						—		—						—				—	—		—	—	—	—	—	—	—	—
	×9	YB2-5004-4	6000	1120	4822	1621	1306	—	—		—		—	—	—	—	—	—	—	—	—	—	—	—						—		—	—	—	—	—	—	—	—			—	—		—	—	—	—	—	—		
	×10	YB2-5601-4	6000	1250	4975	1774	1459	—	—		—		—	—	—	—	—	—	—	—	—	—	—	—						—		—	—	—	—	—	—	—	—			—	—		—	—	—	—	—	—	—	
	×11	YB2-5601-4	6000	1250	5128	1927	1612	—	—		—		—	—	—	—	—	—	—	—	—	—	—	—						—		—	—	—	—	—	—	—	—	—	—	—	—	—	—	—	—	—				
	×12	YB2-5602-4	6000	1400	5281	2080	1765	—	—		—		—	—	—	—	—	—	—	—	—	—	—	—						—		—	—	—	—	—	—	—	—	—	—	—	—	—	—	—	—	—				
	地脚螺栓 GB799-88 (Md×l): M36×800																																																			











泵型号 规格	电机型号	电压 V	功率 kW	机组总 长 L	底座部分							电机部分											泵部分							L <sub>5</sub>	F	e	法兰尺寸														
					L <sub>1</sub>	L <sub>4</sub>	L <sub>6</sub>	B <sub>3</sub>	B <sub>4</sub>	G	n	l <sub>2</sub>	l <sub>1</sub>	B	B <sub>1</sub>	C	H	h	h <sub>1</sub>	k	b <sub>2</sub>	L <sub>3</sub>	L <sub>2</sub>	l <sub>3</sub>	l <sub>4</sub>	H <sub>1</sub>	h <sub>2</sub>	B <sub>2</sub>	b <sub>1</sub>				进口法兰		出口法兰												
100MD45	×2	YB2-200L2-2	380	37	1658	1190	800	0	510	510	195	4	777	379	305	510	258	200	275	27	19	310	785	185	296	279	210	254.5	510	250	373	290	3	进口法兰	D <sub>1</sub>	∅100	n <sub>1</sub> -d <sub>1</sub>										
	×3	YB2-250M-2	380	55	1718	1413	900		600		257		930	465	349	600	323	250	325	33		385	859	277															397	370	400	出口法兰	D <sub>2</sub>	∅145	4-∅18		
	×4	YB2-280S-2	380	75	2123	1557	1100		650		229		1002	536	368	650	345	280	360	38	24	410	933	351															502	435			8-∅23	D <sub>3</sub>		∅170	
	×5	YB2-280M-2	380	90	1969	1698	1100	299			1052		600	419	348																				1012	425											511
	×6	YB2-315S-2	380	110	2123	1929	1400	700	750		265	1172	619	406	374	315	550	50	28	530	1086	499	301	284	210	254.5					510	250		697	435	8-∅23	D <sub>5</sub>	∅100	n <sub>2</sub> -d <sub>2</sub>								
	×7	YB2-315M-2	380	132	2183		1400				269	1052	740	508							750	356												315			550	45	28	530	1160	573					
	×8	YB2-315L1-2	380	160	2293	2138	1600	1310	740		508	750	356		315	550	45	28	530	1234			647																			927		D <sub>7</sub>	∅160		
	×9	YB2-315L1-2	380		2473		1600							1310						740	508	750	356	315	550	45					28	530		45	28		530	1308	721						1015		D <sub>8</sub>
	×10	YB2-315L2-2	380	200	2710	1929	1700	850	750		256	1325	680	508	750	356	315	550	45	28	530	525	1382	795											1028	475	D <sub>9</sub>	∅230									
	×11	YB2-315L2-2	380	200	2784	2174	1800	900	750		243	1325	680									508	750	356	315	550					45	28		530	525	1456	869										
	×12	YB2-355M1-2	380	220	3037	2174	1900	950	850		270	1540	754	560	750	394	355	680	53			680	1530	943																							
	地脚螺栓 GB799-88 (Md×l): M20×300																																														
125MD25	×2	YB2-180M-2	380	22	1471	1150	800	0	590	175	4	683	315	241	530	248	180	250	24	15	285	758	262	277	287	210	300	530	280	425	300	3	进口法兰	D <sub>1</sub>	∅125	n <sub>1</sub> -d <sub>1</sub>											
	×3	YB2-200L1-2	380	30	1668	1404	900			590		252	790	379		305	530	260	200	275	27	19	310							875				352								529	400	出口法兰	D <sub>2</sub>	∅175	8-∅18
	×4	YB2-200L2-2	380	37	1758							1000	263	830		385		311	600	325										250				325	33	24	410	965	442								
	×5	YB2-225M-2	380	45	1898	1526	1000	306		945		465	349	600		325	250	325			33			345	1065						532														674	370	
	×6	YB2-250M-2	380	55	2103	1743	1130	565		660	346	1015	536	368	650	347	280	360	38	24	410	1245	712	287	297					210	300		530	280	817	400	8-∅25	D <sub>5</sub>	∅125	n <sub>2</sub> -d <sub>2</sub>							
	×7	YB2-280S-2	380	75	2263	1993	1300	650		710	320	1045	600	419								650	347												280			360	38	24	410	1335	802				
	×8	YB2-280S-2	380		2353						1993	1300	650	710	320	1045	600	419	650	347	280	360	38	24	410					1425	892											D <sub>7</sub>	∅220				
	×9	YB2-280M-2	380	90	2493	2141	1500	750		320	1045	600	419	650	347	280	360	38	24	410	1425	892														D <sub>8</sub>		∅270									
	地脚螺栓 GB799-88 (Md×l): M20×300																																														
150MD30	×2	YB2-225M-4	380	45	1903	1382	1000	—	720	191	4	845	390	311	640	289	225	225	27	19	345	1054	310	388	413	280	350	640	350	515	400	4	进口法兰	D <sub>1</sub>	∅150	n <sub>1</sub> -d <sub>1</sub>											
	×3	YB2-280S4-4	380	75	2173	1636	1200			600		780	218	1000	540	368	700	330	280	280	38	24	410							1169				425								624	435	出口法兰	D <sub>2</sub>	∅214	8-∅23
	×4	YB2-280M-4	380	90	2338	1825	1300			650		254	1050	600	419	780														396				315	315	45	28	576	1284	540							
	×5	YB2-315S-4	380	110	2523	2040	1500	750		270		1235	670	457	780		396	315	315	45	28	576	1429	655	418						443								280	350	640	350			822	435	
	×6	YB2-315M-4	380	132	2823	2180	1700	850		240	1285	670				457							780	396						315			315	45	28	576	1544	770									
	×7	YB2-315L1-4	380	160	3003	2471	1900	950		860	286	1340	740	508	780	396	315	315	45	28	576	1659	885	418	443					280	350		640	350	992	435	8-∅25	D <sub>6</sub>	∅236								
	×8	YB2-315L1-4	380		3118																	2471	1900												950			860	286	1340	740	508	780	396	315	315	45
	×9	YB2-315L2-4	380	200	3233	2701	2000	1000		610	350	1570	754	560	610	424	355	680	53	28	680	1889	1115	418	443					280	350		640	350	1621	400		8-∅25	D <sub>8</sub>	∅300							
	×10	YB2-315L2-4	380		3348																	2701	2000												1000				610	350	1570	754	560	610	424	355	680
	×11	YB2-355M1-4	380	220	3693	1385	1085	—		610	150	1570	754	560	610	424	355	680	53	28	680	2119	1345	418	443																						
	×12	YB2-355M2-4	380	250	3763	1500	1200	—		610	150	1525	760	560	610	424	355	655	52	28	655	2234	1460	418	443																						
	地脚螺栓 GB799-88 (Md×l): M24×400																																														





锦 州 大 洋 泵 业 制 造 有 限 公 司

JIN ZHOU DA YANG BEN YE ZHI ZAO YOU XIAN GONG SI

地址:辽宁省锦州市太和区解放西路 118 号

电话:0416-5178778

传真:0416-5179575

<http://www.dypumps.com/>

<http://www.dypump.cn/>

<http://www.dyby.cn/>

本产品使用说明书依据 GB/T9969-2008 《工业产品使用说明书总则》编制，2011 年 11 月第一版，第一次印刷

MD 型矿用耐磨多级离心泵